

Project

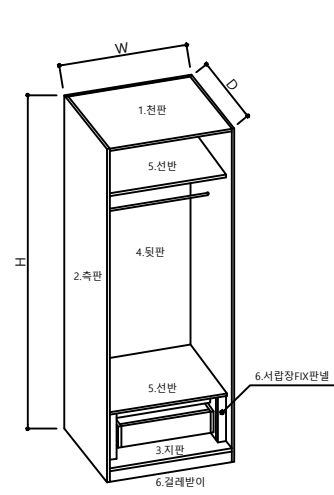

반침장

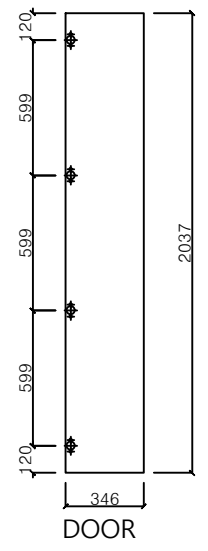

DOOR

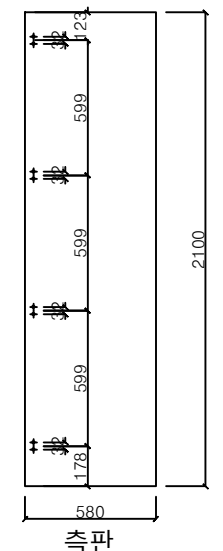

측판

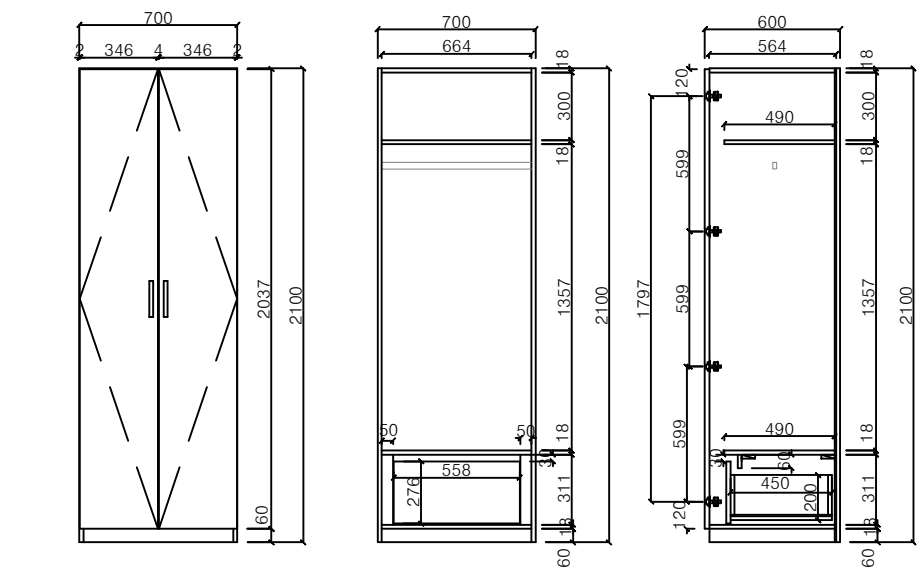

반침장

FRONT VIEW INNER VIEW SIDE VIEW

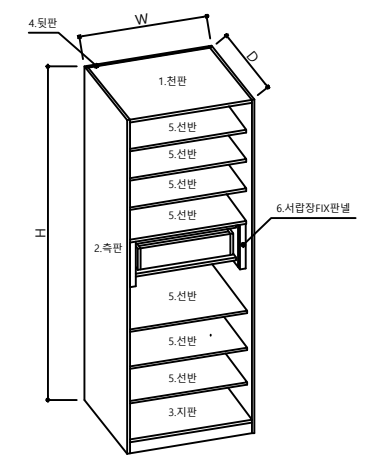

현관장

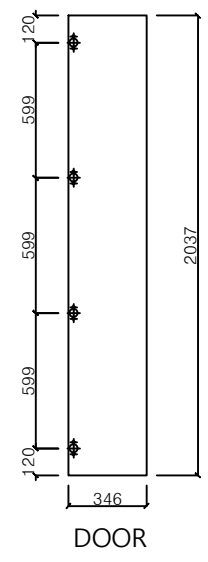

DOOR

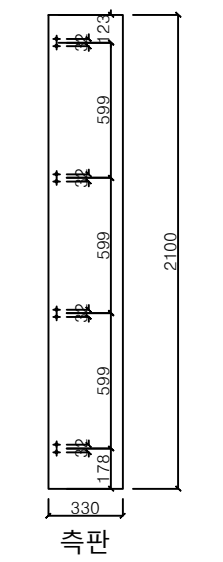

측판

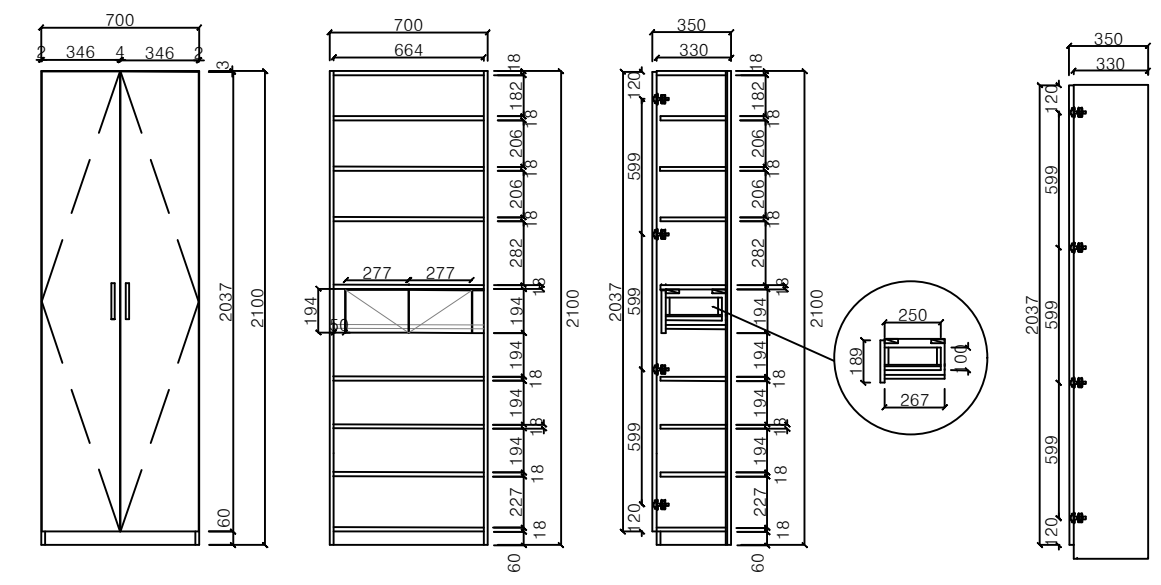

현관장

FRONT VIEW INNER VIEW SIDE VIEW

DOOR(18T PB)	
COLOR	LPM
엣지	1T PVC 엣지마감
손잡이	목찬넬
BODY(18T PB)	
COLOR	양면 LPM
엣지	전면동일 색상 엣지 마감
휠라,EP,FIX(18T PB)	
COLOR	LPM
엣지	1T PVC 엣지마감

철물류
 경첩 - 일반, 댐핑
 3단 볼레일(250)
 일반철레일(450)

Title
 내포 신도시

scale

Date
 2022. 01.05

작성자 홍명화



실내건축공사, 사무·주택용가구 전문업체
(주) 사모스
 TEL.070-4786-8000 FAX.(042)273-0403
 E.mail : samos8212@hanmail.net