

TOP VIEW

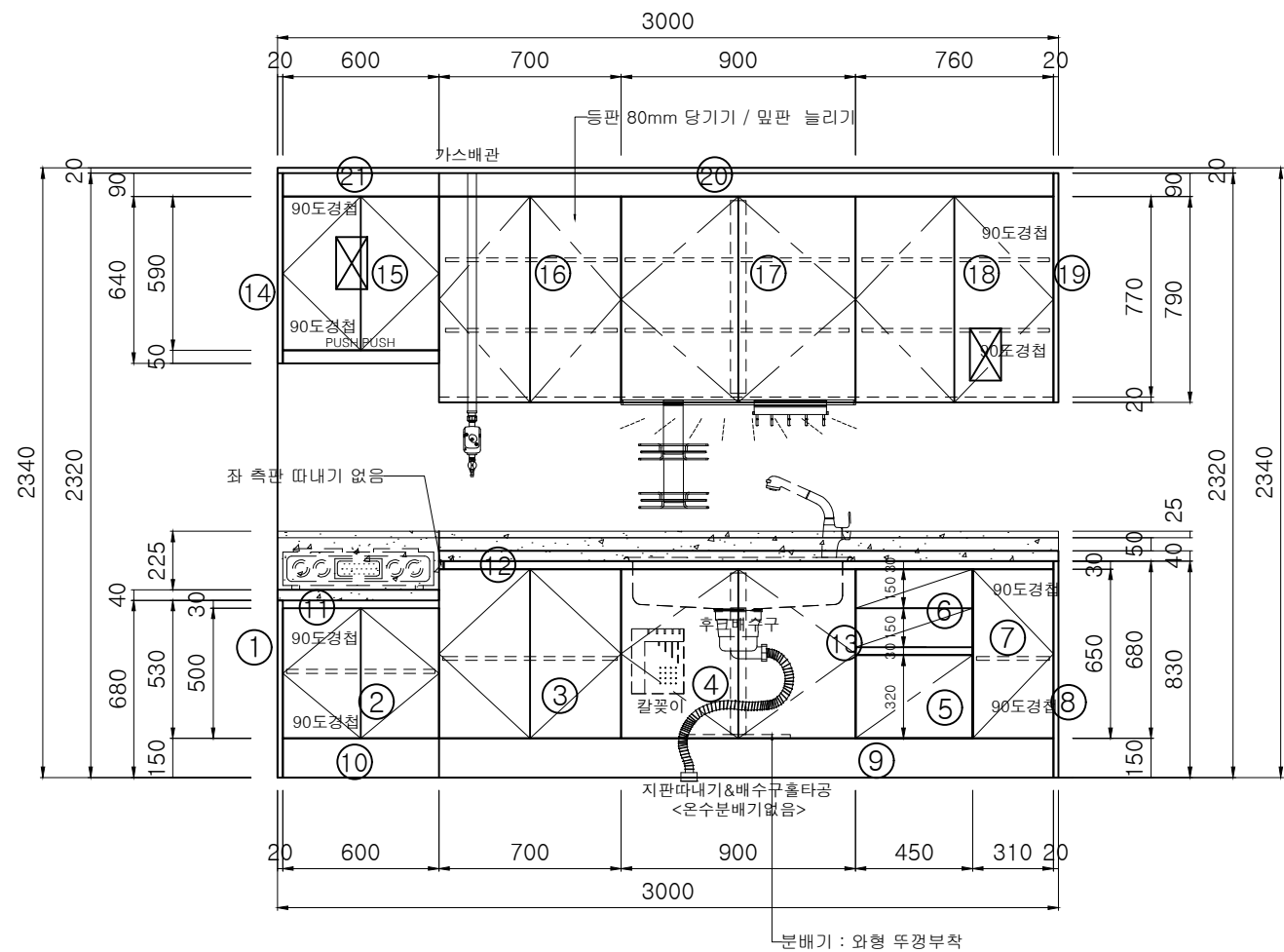

ELEVATION-A

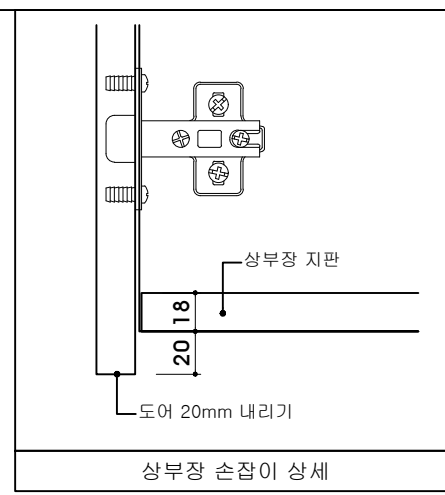

상부장 손잡이 상세

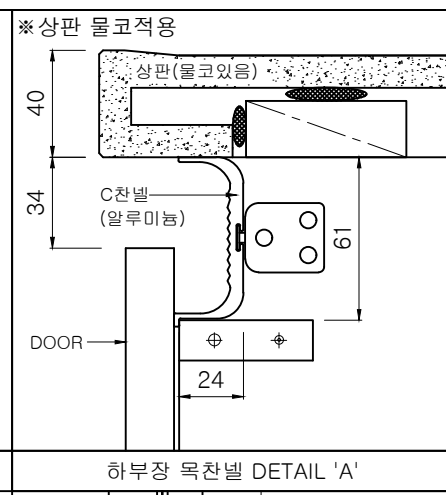

하부장 목찬널 DETAIL 'A'

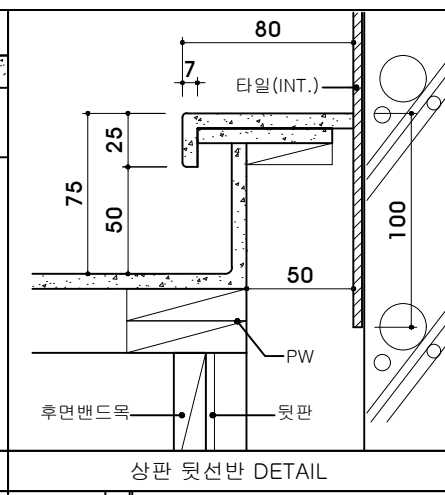

상판 뒷선반 DETAIL

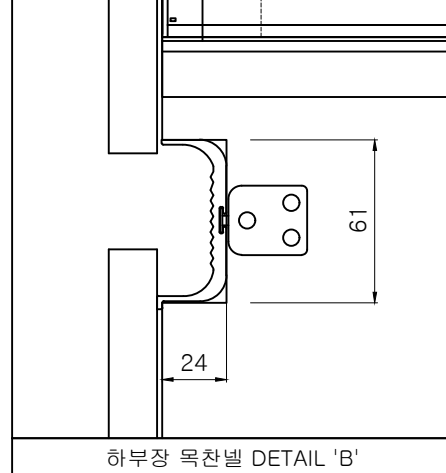

하부장 목찬널 DETAIL 'B'

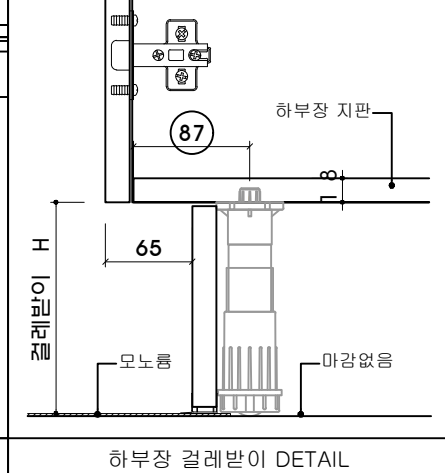

하부장 걸레받이 DETAIL

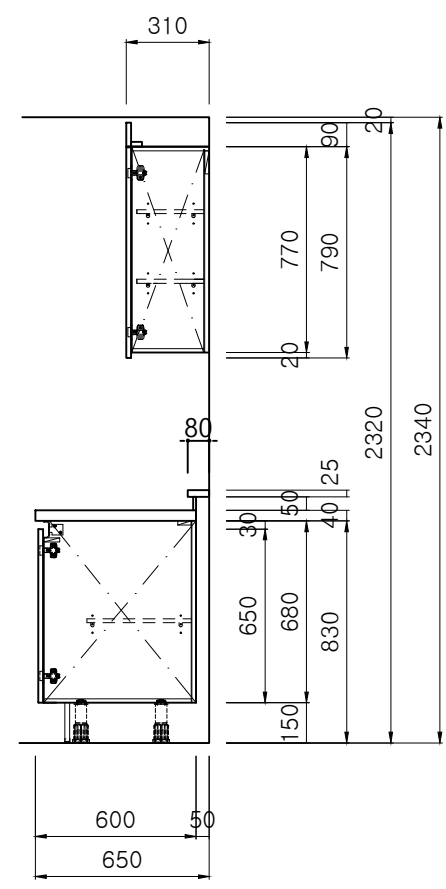

SIDE VIEW-A

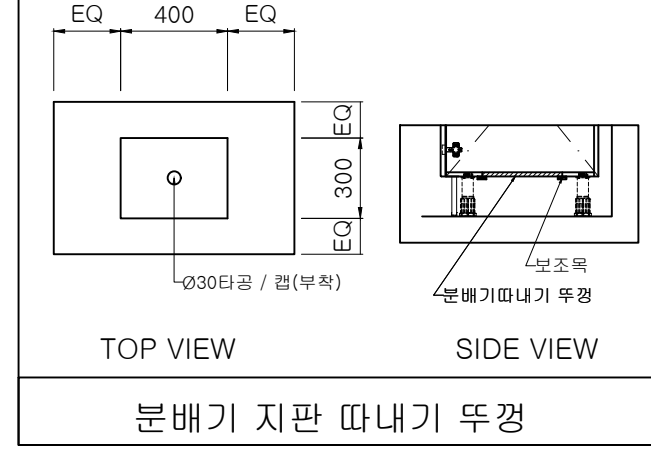

분배기 지판 따내기 두경

건설사	내공사
현장명	의왕부곡 장안마을
평형	36B타입
ITEM	KITCHEN

<상부장>

양면 HPL(0.45T) / 엣지  
포밍시 2면 2T 데코시트(PVC)  
or 4면 1T PET(PUR접착)

<하부장>

양면 HPL(0.45T) / 엣지  
포밍시 2면 2T 데코시트(PVC)  
or 4면 1T PET(PUR접착)

SCALE	A3:1/30, A4:1/40
DRAWING NO.	
SHEET NO.	
구분	
DATE	
최초	
수정	2025.08.28
최종	

**coosto**

(주)동원가구

경기도 용인시 처인구 덕성산단1로 28번길 15  
TEL (031) 321-6752 FAX (031) 718-6759