

상부도어 손잡이

상부물딩 상세도

하부장 손잡이 (목천널)

온수분배기 가림판 상세도

가스배관장치판따내기

상부시공상세도(1단철물보강)

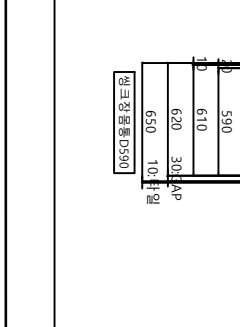
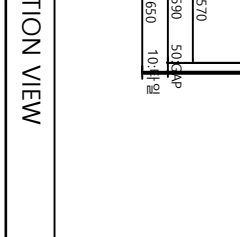
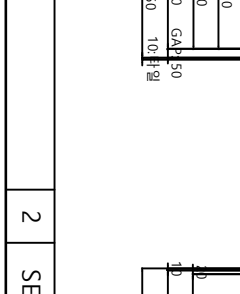
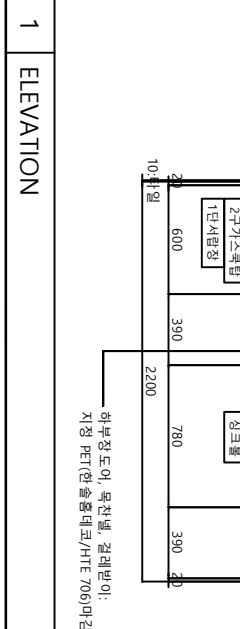
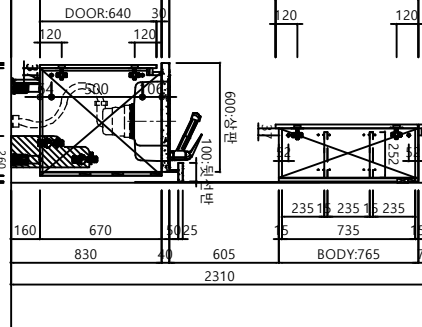
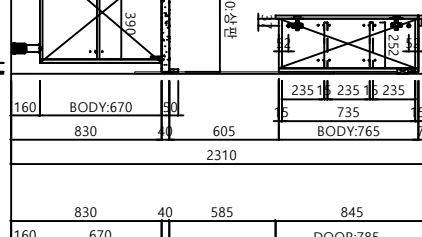
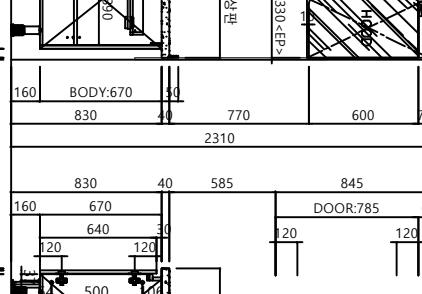
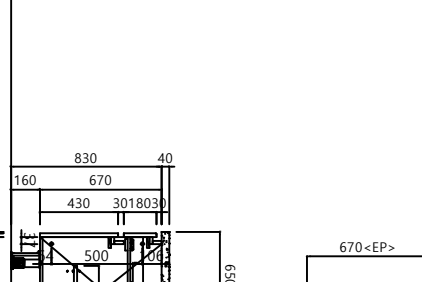
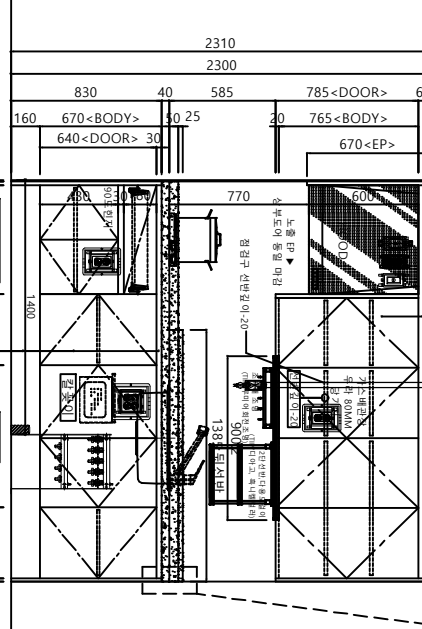
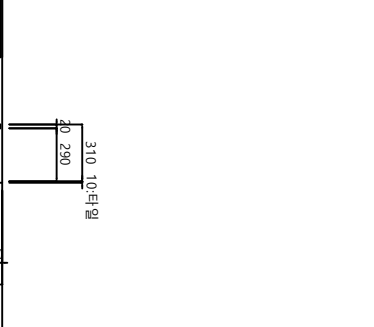
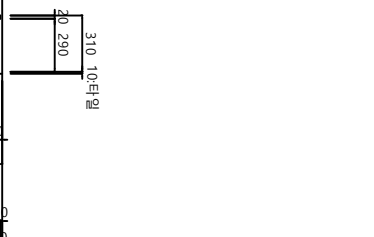
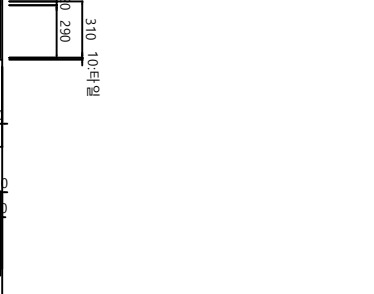
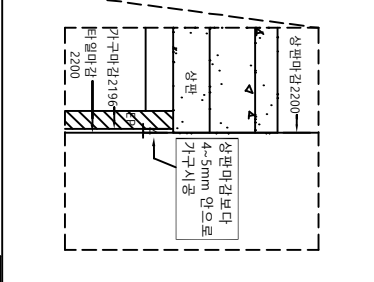
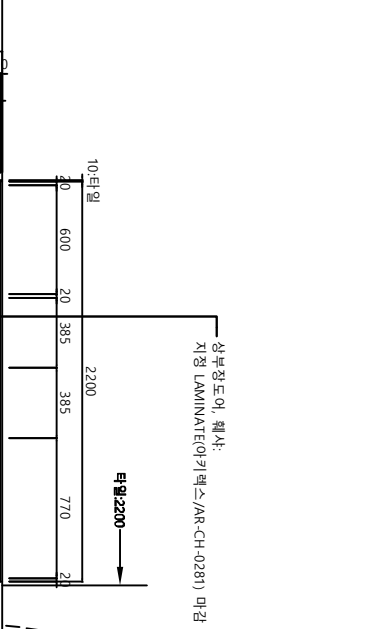

구분	도대	도반	계
1분절	33	33	66
계	33	33	66

CLIENT: SH  
PROJECT TITLE: 고덕강일 3지구 11단지  
MODEL TITLE: 입면도  
DRAWING TITLE: 29BS

CHECKED BY: [Blank]  
APPROVAL BY: [Blank]  
DATE: 2020. 07. 06  
SHEET NO.: [Blank]  
SCALE: [Blank]

**furnione**  
FURNITURE-NO.1

주식회사 퍼니원  
경기도검포시 용평동영로 206번길 47  
TEL. 032-819-8614 / FAX. 032-819-8614

NOTE  
1.타보 : 인서트다보 적용  
2.분배기 타공면 지정 물임부착

