

* 칼꽃이보류
* 1구 콘센트 보류

분 류	본납			
	타입별	59A㎡	59B㎡	59C㎡
세대수	379세대	49세대	49세대	162세대
합 계	639세대			

DATE : 2020. 07. 14.

협의용 도면 업체제출용 도면 MH / SH 도면 자재발주용 도면 생산용 도면

설계작성	김민정 (010-6365-8961)	공사관리자	박진태 (010-6619-9633)	작도	승인	승인란 / P.L 특기사항					
작성일	2020. 07. 14.	설치담당자	최진복 (010-9307-7123)			<ul style="list-style-type: none"> * 멩기둥: 25T 150mm 멩기둥 * 엣지: 측판 3면, 천지판 1면, 하부장지판3면, 이동선반 4면 * 연결볼트 적용 * 상판포함 * 행거약세사리 포함 * 기기류 제외 * 전면 측다보 후면 평다보 					
현장담당자 (건설사)											
본사 연락처	경남 김해시 생림면 나전로 238-25 / TEL : 055)323-8866, FAX : 055)323-8835			/	/						
M/H 주소											
현장 주소	충주시 호암수청2로 74 (호암동)										
도면 개정 (기록일자)	1	2	3	4	5	6	7	8	9	10	<div style="border: 1px solid black; border-radius: 50%; padding: 10px; text-align: center;"> <p>승인</p> <p>2020. 07. 14.</p> <p>ZENOLINE</p> </div>
	/	/	/	/	/	/	/	/	/	/	
	도면매수 총 : 23 매(표지제외)										

ZENOLINE
(주) 제노라인

결재	제노라인	건설사

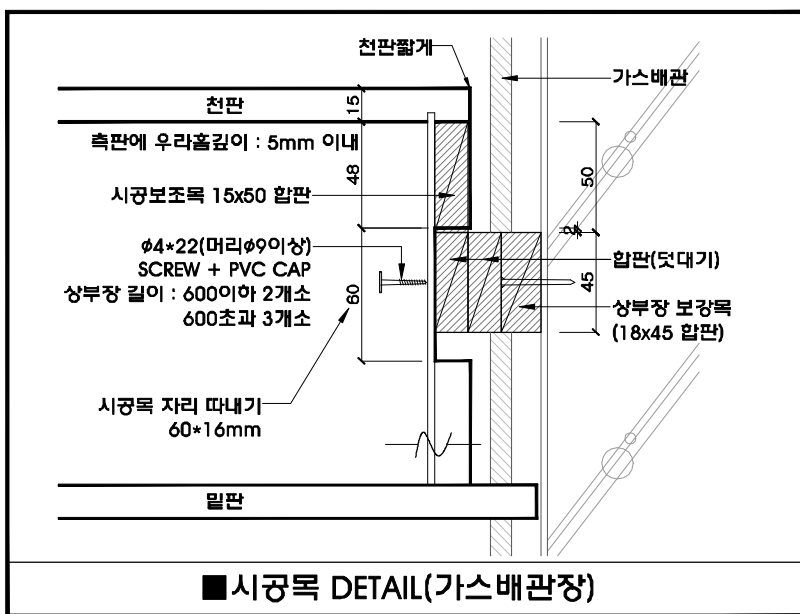
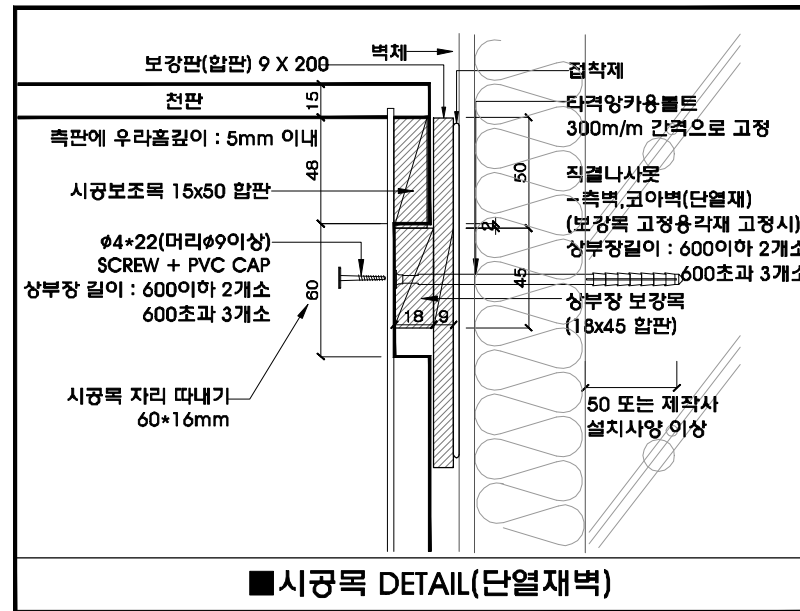
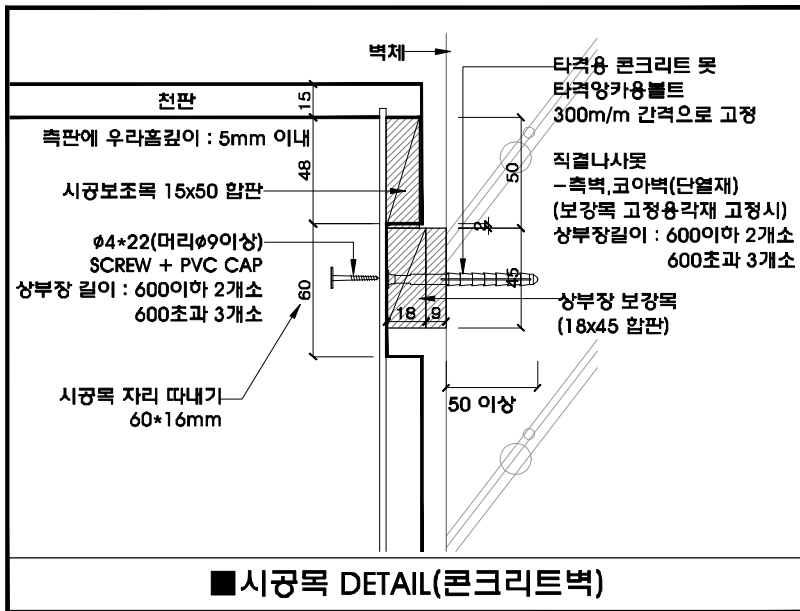

ZENOLINE
(주) 제노라인

경남 김해시 성림면 나전로 238-25
TEL. 056) 328 - 8866 FAX. 056) 323 - 8836
Homepage : http : //zenoline.co.kr

SHEET NO.

별첨

59A/B/D

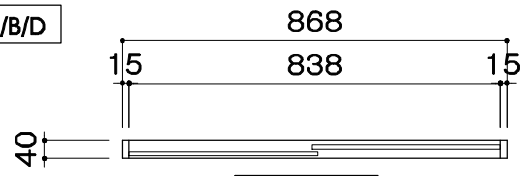

TOP VIEW

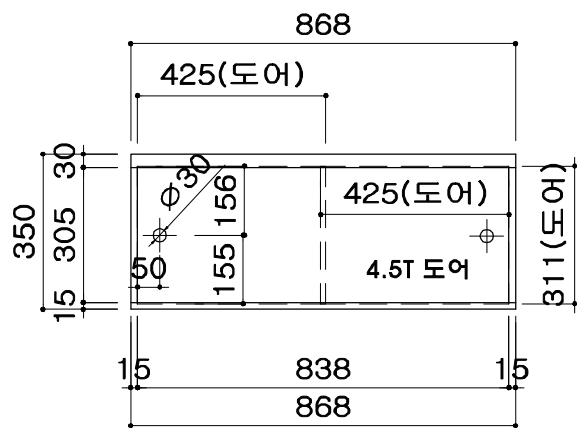

FRONT VIEW

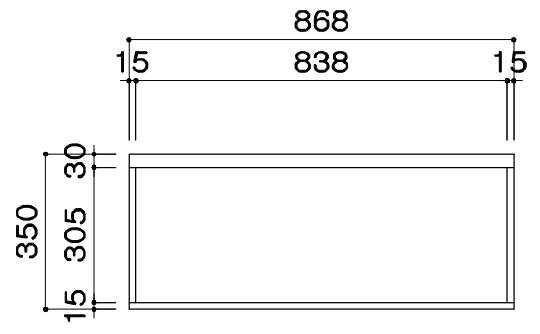

INNER VIEW

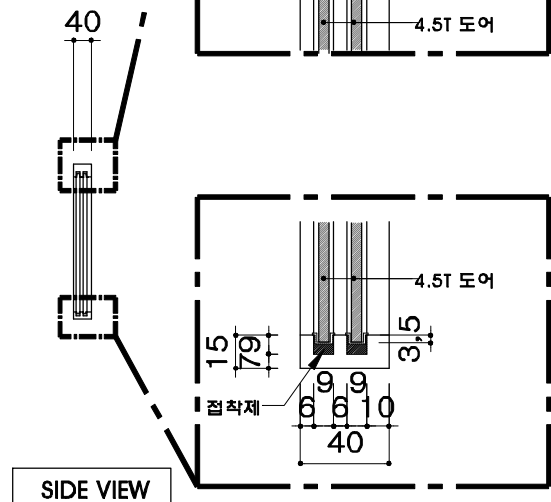

SIDE VIEW

59C

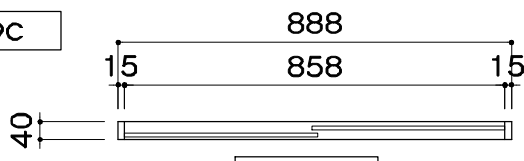

TOP VIEW

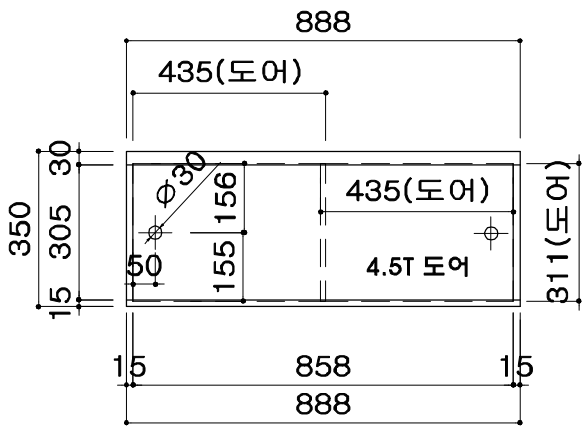

FRONT VIEW

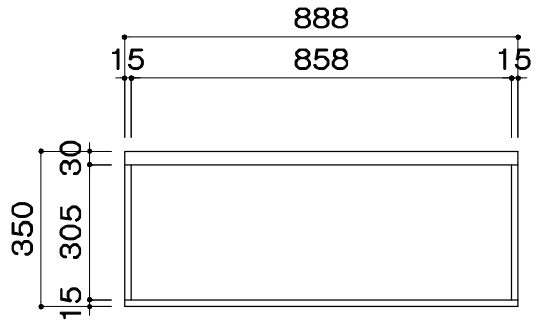

INNER VIEW

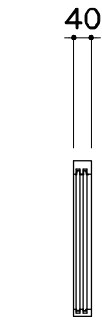

SIDE VIEW

현장명 **LH** 현대건설
 층주호암지구 A-1BL
 TYPE
 ITEM 분배기커버

2		
1		
NO.	수정일	도면수정내용
SCALE NON SCALE		
DATE 2020. 07. 14.		
DRAWN BY 김민정		

ZENOLINE
 (주) 제노라인
 경남 김해시 상림면 나전로 238-26
 TEL. 056) 323 - 8866 FAX. 056) 323 - 8835
 Homepage : http : //zenoline.co.kr

SHEET NO. **별첨**

삼성정밀 NEW IREX BOX 500레일

TYPE

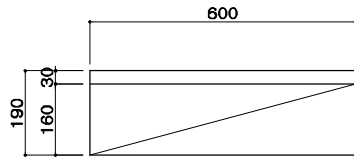

FRONT VIEW

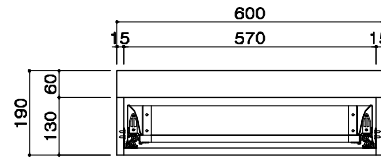

INNER VIEW

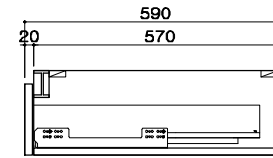

SIDE VIEW

샘플 확인 후 제작

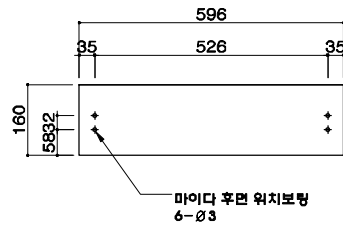

마이다 보링도

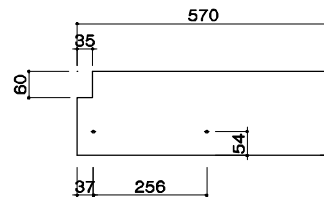

측판보링도

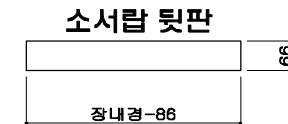

2		
1		
NO.	수정일	도면수정내용
SCALE NON SCALE		
DATE 2020. 07. 09.		
DRAWN BY		

ZENOLINE

(주) 제노라인

경남 김해시 상림면 나전로 238-26
TEL. 055) 323 - 8866 FAX. 055) 323 - 8835
Homepage : http : //zenoline.co.kr

SHEET NO.

별첨

삼성정밀 NEW IREX BOX 500레일

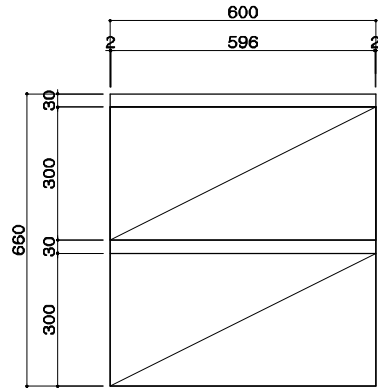

FRONT VIEW

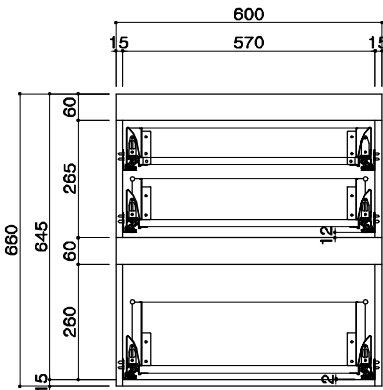

INNER VIEW

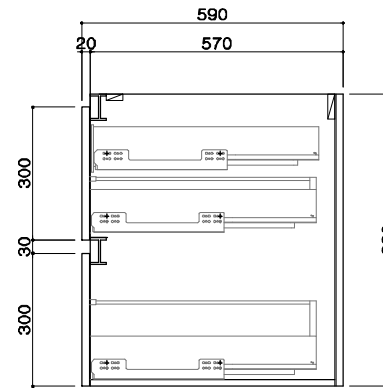

SIDE VIEW

샘플 확인 후 제작

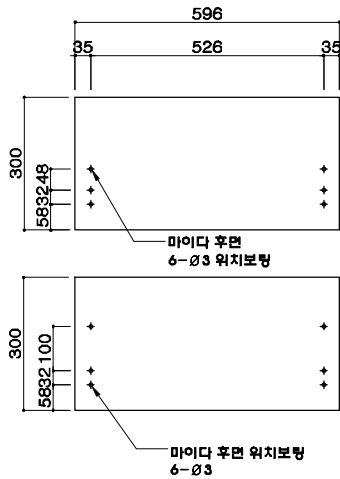

마이디 보강도

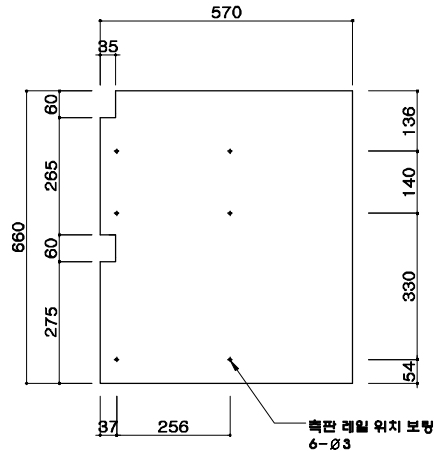

측판보강도



속서랍 뒷판

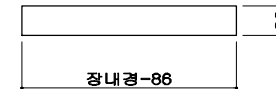

소서랍 뒷판

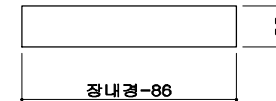

대서랍 뒷판



TYPE

2		
1		
NO.	수정일	도면수정내용
SCALE NON SCALE		
DATE 2020. 07. 09.		
DRAWN BY		

ZENOLINE

(주) 제노라인

경남 김해시 상림면 나전로 238-26
TEL. 055) 323 - 8866 FAX. 055) 323 - 8835
Homepage : http : //zenoline.co.kr

SHEET NO.

별첨

샘플 확인 후 제작

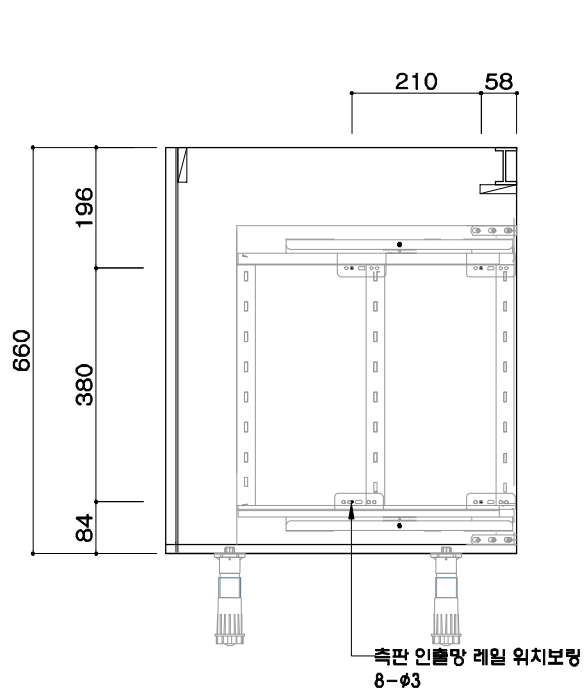

-측판 보링도-

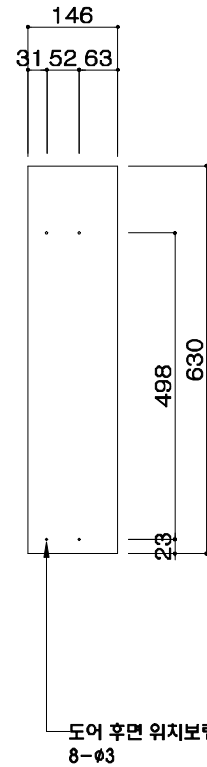

-도어 보링도-

2		
1		
NO.	수정일	도면수정내용
SCALE		NON SCALE
DATE		2020. 07. 09.
DRAWN BY		

ZENOLINE

(주) 제노라인

경남 김해시 상림면 나전로 238-26
TEL. 055) 323 - 8866 FAX. 055) 323 - 8835
Homepage : http : //zenoline.co.kr

SHEET NO.

별첨

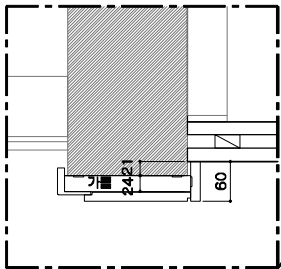
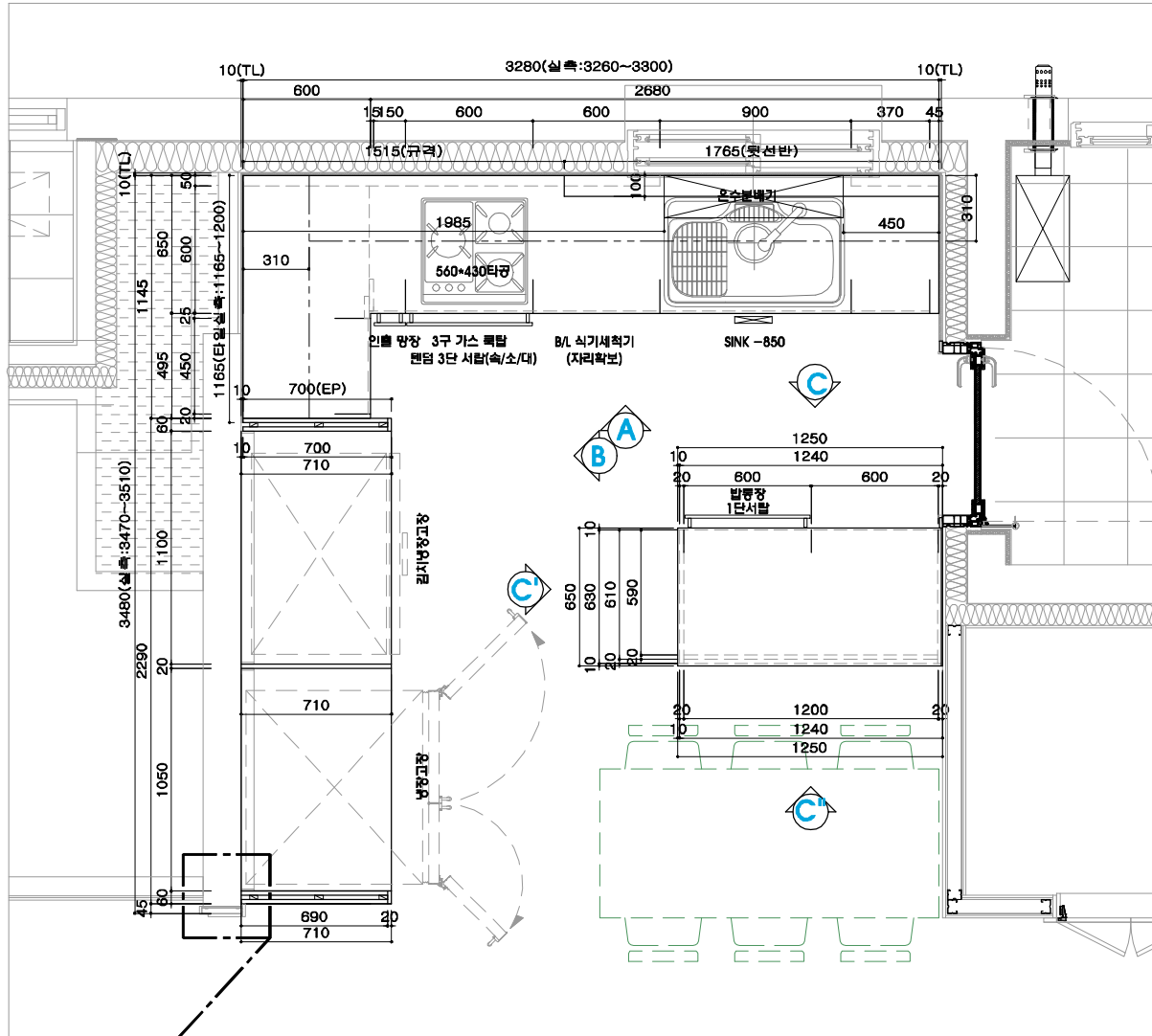

PLAN OF KITCHEN

승인
 2020. 07. 14.
 ZENOLINE

2		
1		
NO.	수정일	도면수정내용
SCALE NON SCALE		
DATE 2020. 07. 14.		
DRAWN BY 김민정		

ZENOLINE
 (주) 제노라인
 경남 김해시 상림면 나전로 238-25
 TEL. 056) 323 - 8866 FAX. 056) 323 - 8835
 Homepage : http : //zenoline.co.kr

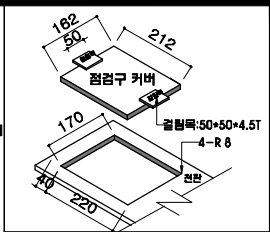
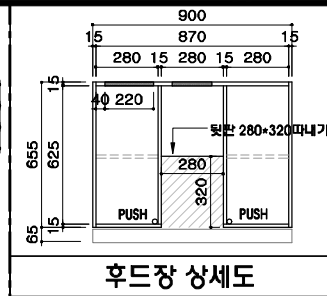
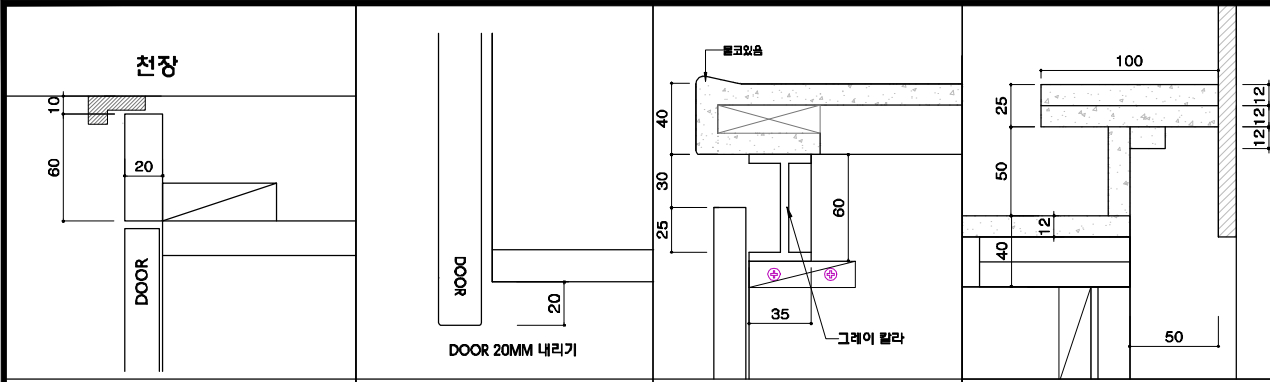

상부활라 DETAIL

상부장 손잡이 DETAIL

하부장 손잡이 DETAIL

뒷선반 DETAIL

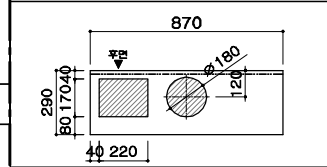

상부 점검구 DETAIL

후드장 천판 타공도

현장명 **LH 현대건설**
층주호암지구 A-1BL

TYPE **59㎡A type**
 ITEM **KITCHEN**

도면방향	143 - SET
도면반대	236 - SET
총수량	379 - SET

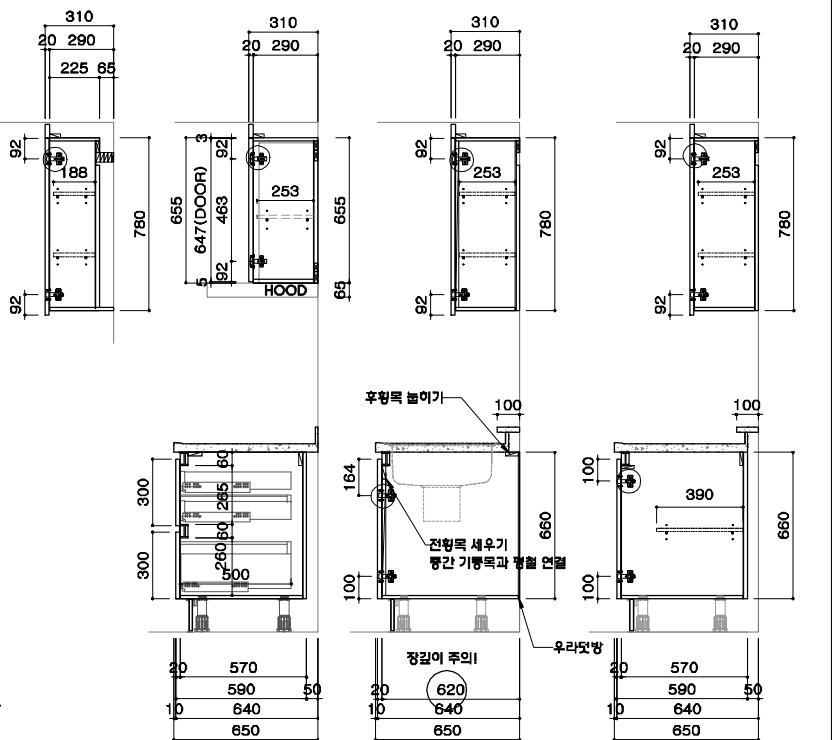
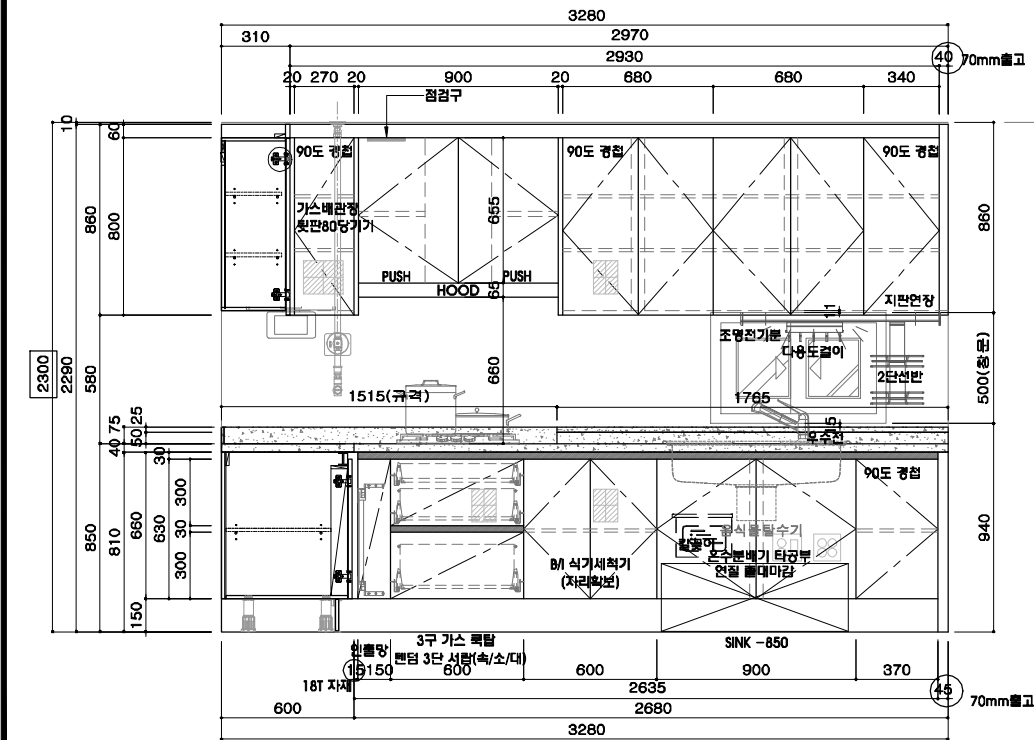

2		
1		
NO.	수정일	도면수정내용
SCALE NON SCALE		
DATE 2020. 07. 14.		
DRAWN BY		김민정

ZENOLINE
 (주) 제노라인

경남 김해시 상림면 나전로 238-25
 TEL. 055) 323 - 8866 FAX. 055) 323 - 8835
 Homepage : http://zenoline.co.kr

TYPE	59㎡A type
ITEM	KITCHEN
도면방향	143 - SET
도면반대	236 - SET
총수량	379 - SET

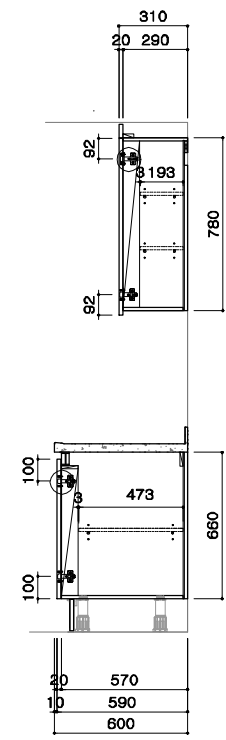
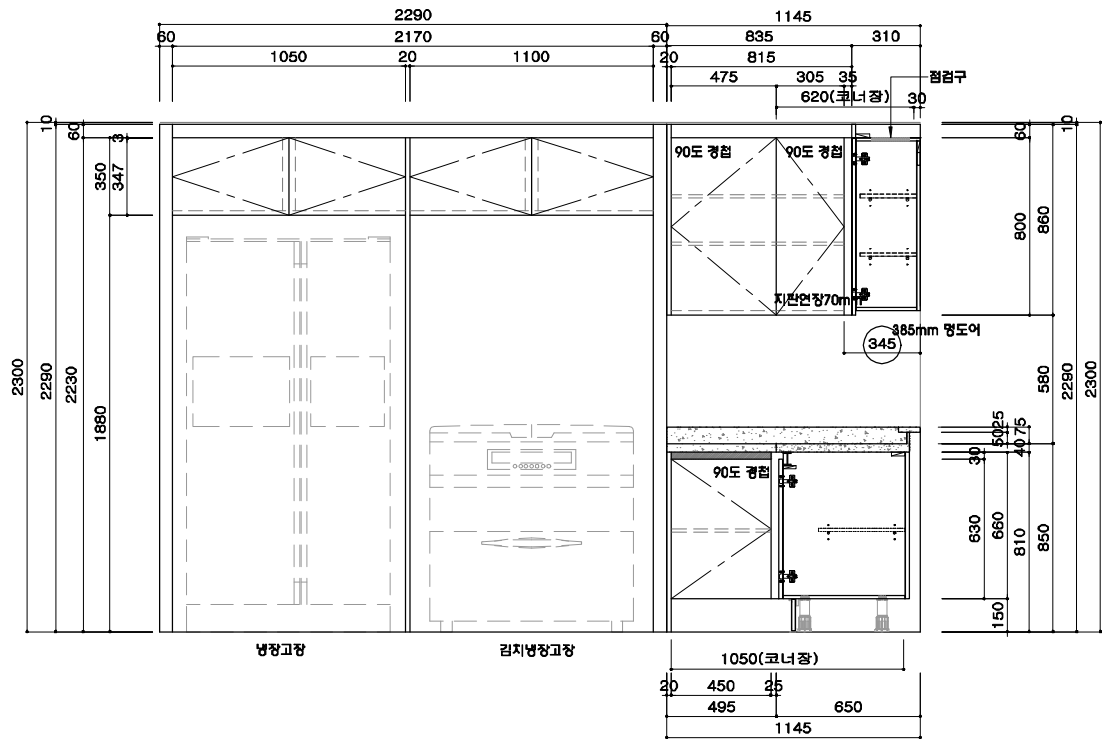
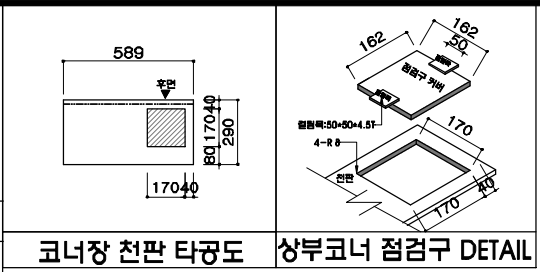
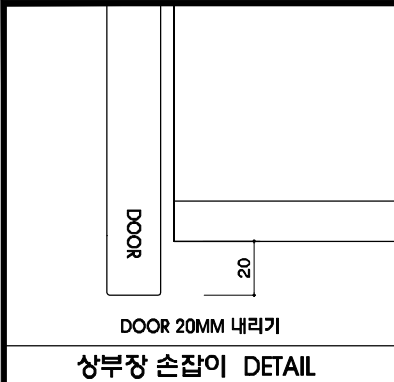

승인
2020. 07. 14.
ZENOLINE

2		
1		
NO.	수정일	도면수정내용
SCALE NON SCALE		
DATE 2020. 07. 14.		
DRAWN BY		김민정

ZENOLINE
 (주) 제노라인

경남 김해시 상림면 나전로 238-25
 TEL. 055) 323 - 8866 FAX. 055) 323 - 8835
 Homepage : http : //zenoline.co.kr

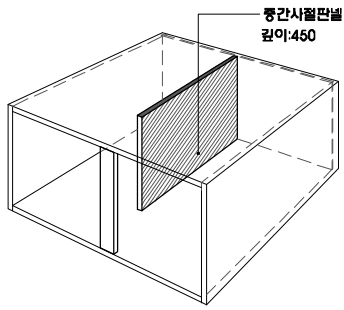

냉장고장 상부장 DETAIL

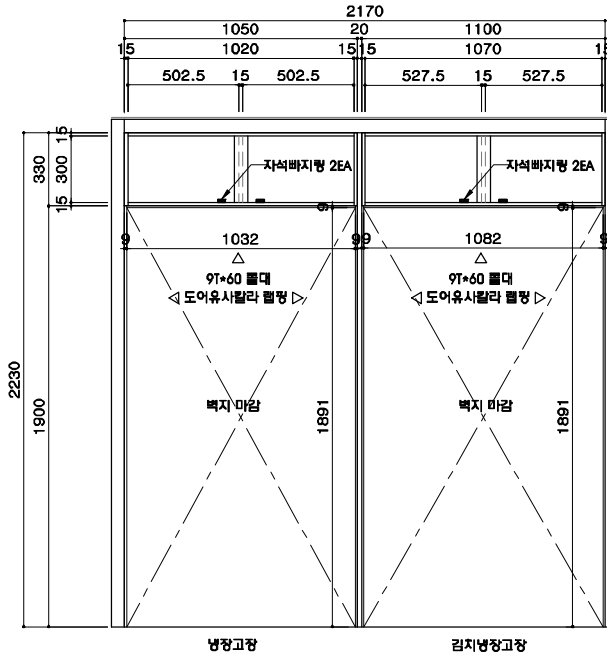

INNER VIEW

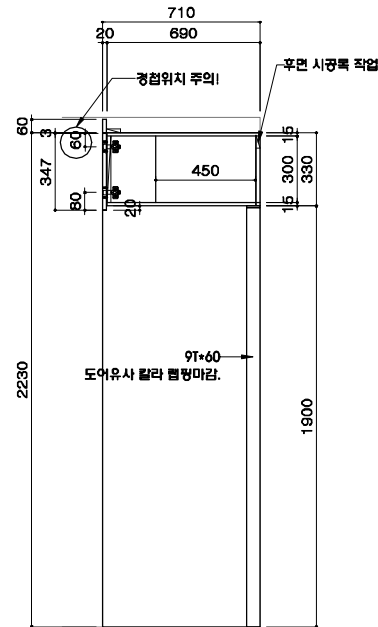

SIDE VIEW

TYPE	59㎡A type
ITEM	KITCHEN
도면방향	143 - SET
도면반대	236 - SET
총수량	379 - SET



2		
1		
NO.	수정일	도면수정내용
SCALE NON SCALE		
DATE 2020. 07. 14.		
DRAWN BY 김민정		

ZENOLINE
(주) 제노라인

경남 김해시 상림면 나전로 238-25
TEL. 056) 323 - 8866 FAX. 056) 323 - 8835
Homepage : http : //zenoline.co.kr

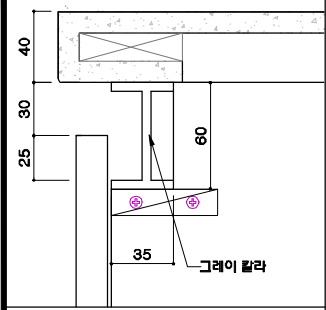

하부장 손잡이 DETAIL

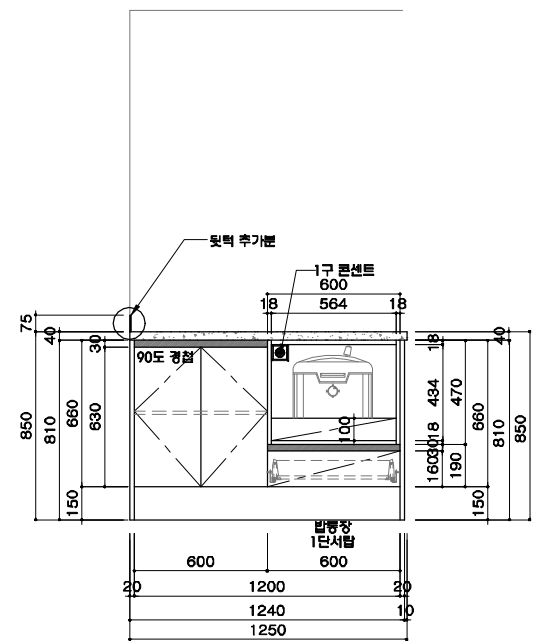

ELEVATION

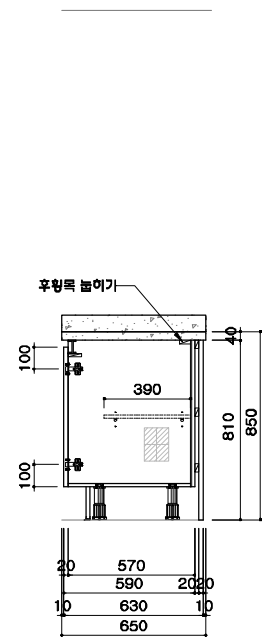

SIDE VIEW

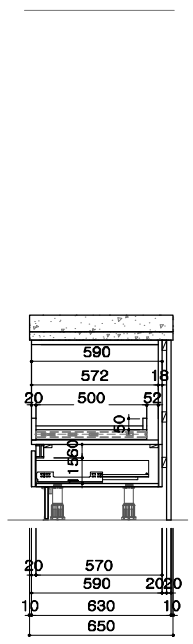

ELEVATION

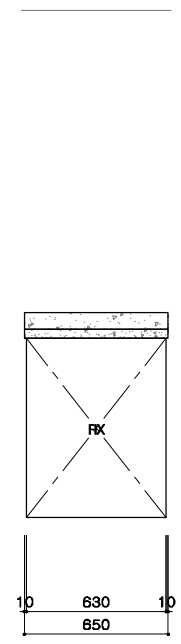

ELEVATION

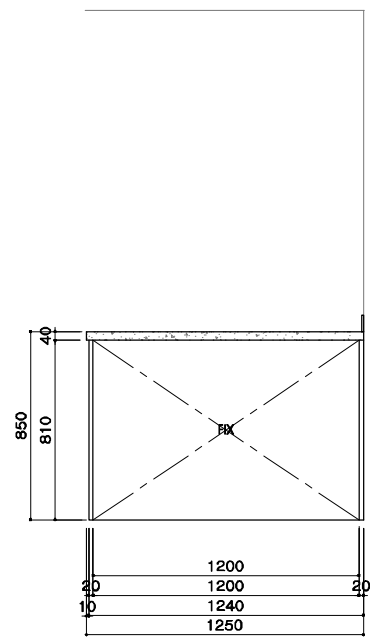

2		
1		
NO.	수정일	도면수정내용
SCALE NON SCALE		
DATE 2020. 07. 14.		
DRAWN BY		김민정

ZENOLINE
(주) 제노라인

경남 김해시 상림면 나전로 238-25
TEL. 055) 323 - 8866 FAX. 055) 323 - 8835
Homepage : http : //zenoline.co.kr

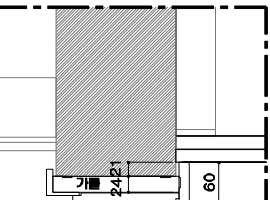
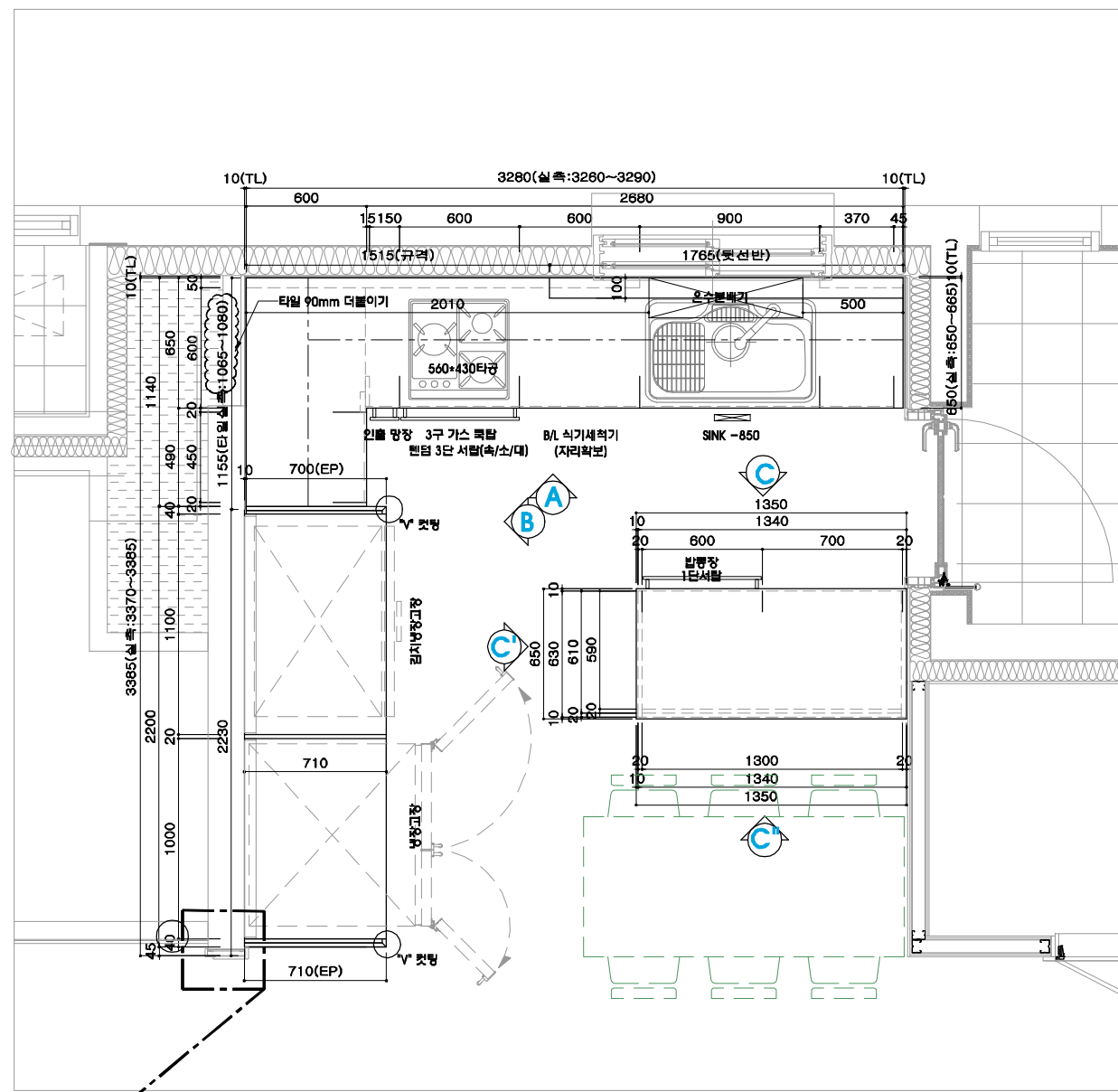

PLAN OF KITCHEN

승인
2020. 07. 14.
ZENOLINE

2		
1		
NO.	수정일	도면수정내용
SCALE NON SCALE		
DATE 2020. 07. 14.		
DRAWN BY 김민정		

ZENOLINE
(주) 제노라인
경남 김해시 상림면 나전로 238-26
TEL. 056) 323 - 8866 FAX. 056) 323 - 8835
Homepage : http : //zenoline.co.kr

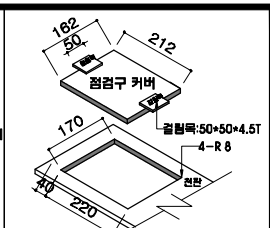
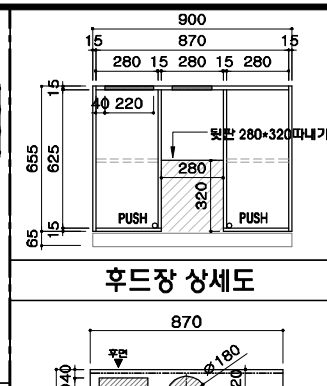
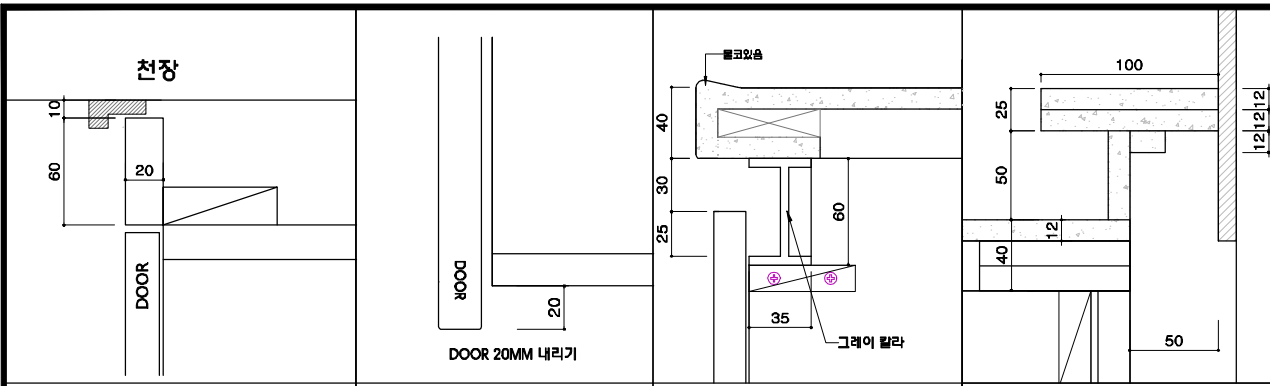

상부활라 DETAIL

상부장 손잡이 DETAIL

하부장 손잡이 DETAIL

뒷선반 DETAIL

후드장 상세도

상부 점검구 DETAIL

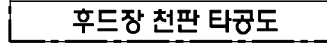

후드장 천판 타공도

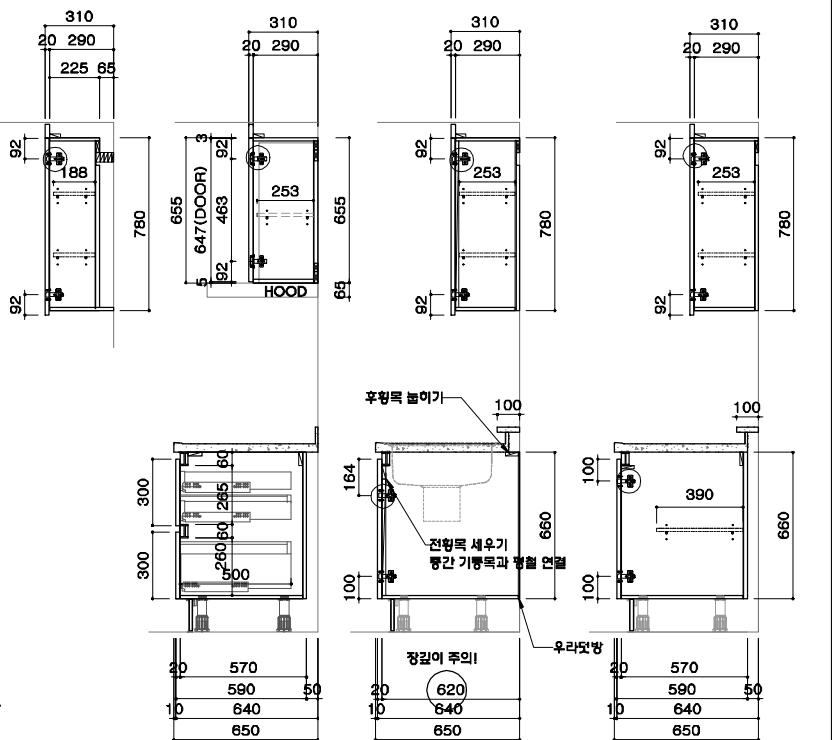
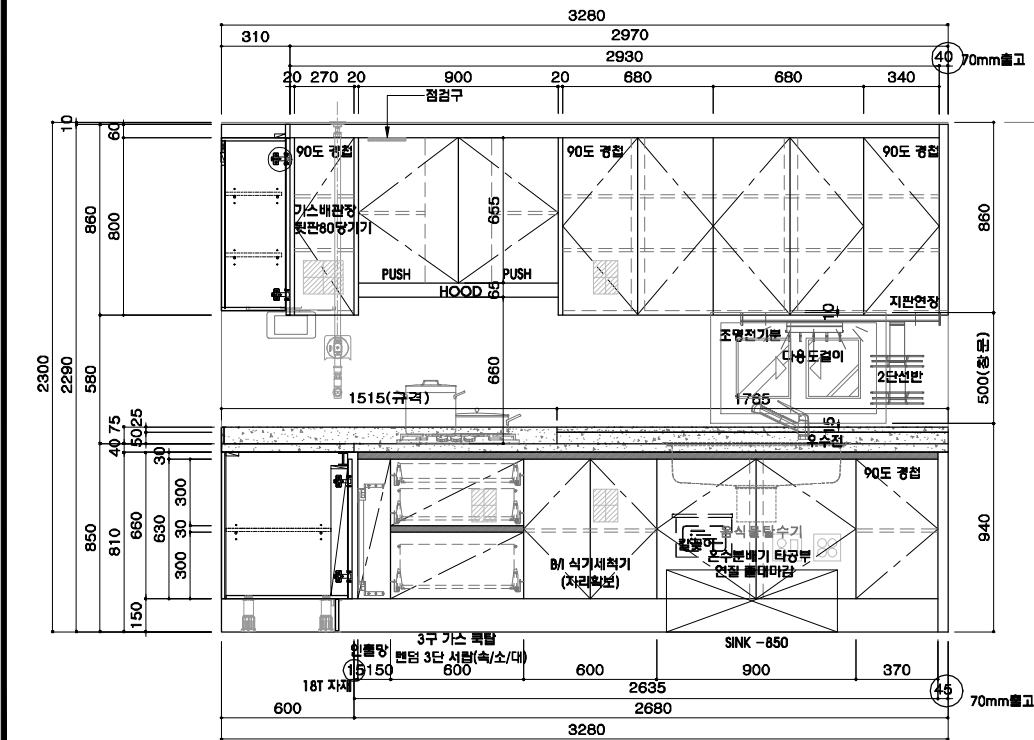

현장명 **LH 현대건설**
층주호암지구 A-1BL

TYPE	59㎡B type
ITEM	KITCHEN
도면방향	24 - SET
도면반대	25 - SET
총수량	49 - SET

2		
1		
NO.	수정일	도면수정내용
SCALE NON SCALE		
DATE 2020. 07. 14.		
DRAWN BY		김민정



TYPE 59㎡B type

ITEM KITCHEN

도면방향 24 - SET

도면반대 25 - SET

총수량 49 - SET

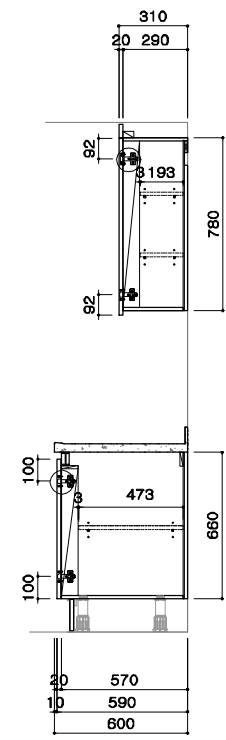
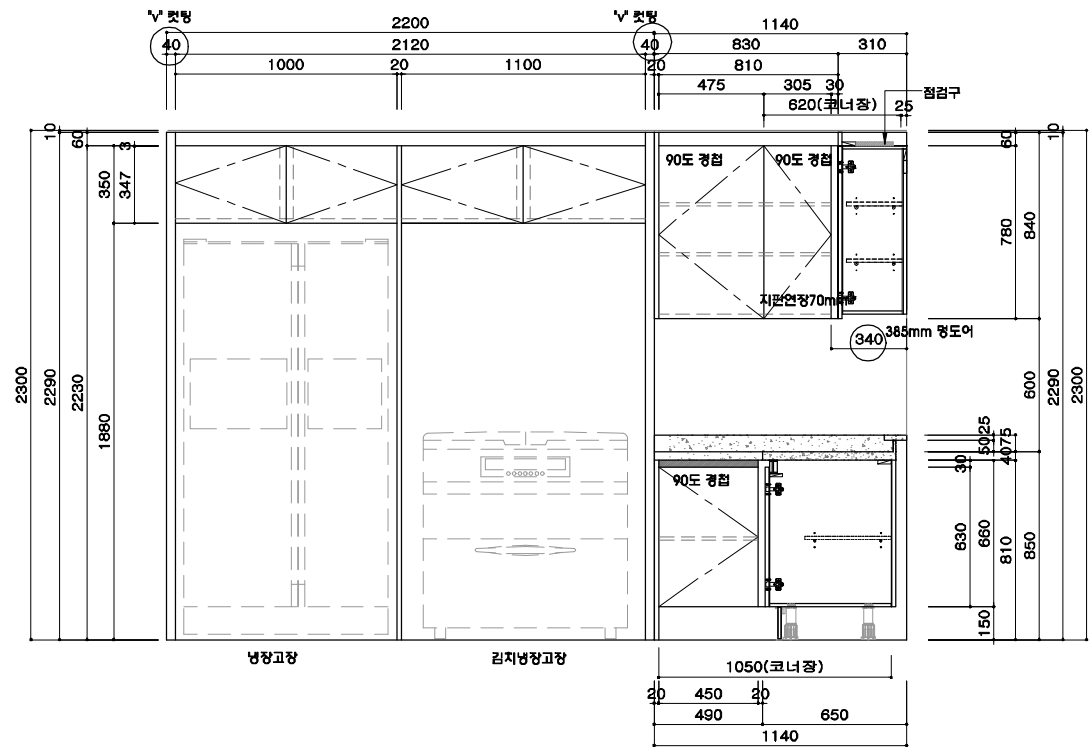
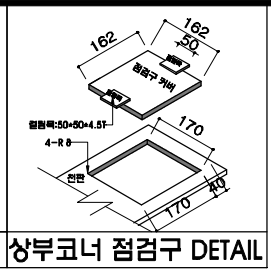
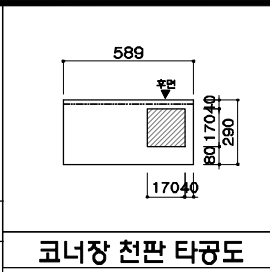
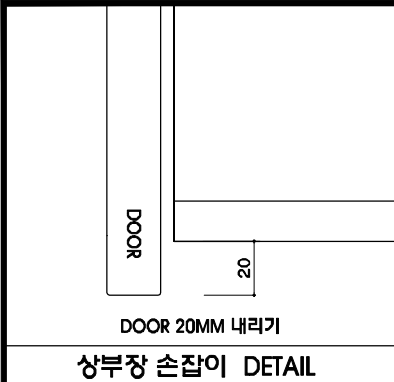

승인
2020. 07. 14.
ZENOLINE

2		
1		

NO. 수정일 도면수정내용

SCALE NON SCALE

DATE 2020. 07. 14.

DRAWN BY 김민정

ZENOLINE
(주) 제노라인

경남 김해시 상림면 나전로 238-25
TEL. 056) 323 - 8866 FAX. 056) 323 - 8835
Homepage : http://zenoline.co.kr

SHEET NO. 9

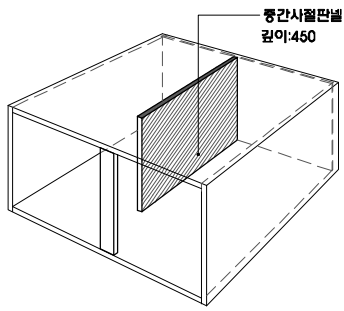

냉장고장 상부장 DETAIL

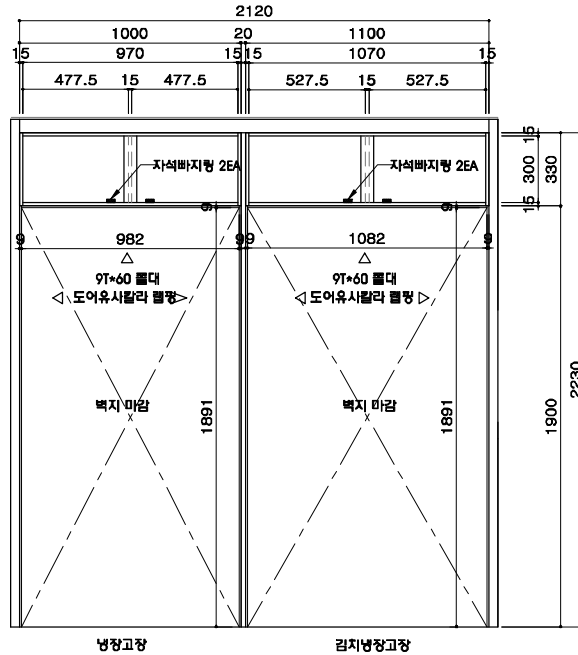

INNER VIEW

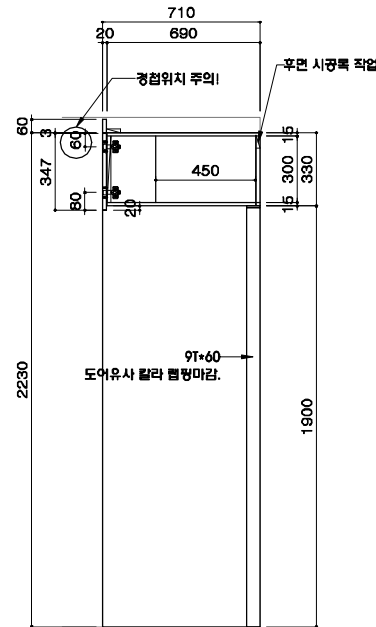

SIDE VIEW

TYPE	59㎡B type
ITEM	KITCHEN
도면방향	24 - SET
도면반대	25 - SET
총수량	49 - SET



2		
1		
NO.	수정일	도면수정내용
SCALE NON SCALE		
DATE 2020. 07. 14.		
DRAWN BY 김민정		

ZENOLINE
(주) 제노라인

경남 김해시 상림면 나전로 238-25
TEL. 055) 323 - 8866 FAX. 055) 323 - 8835
Homepage : http : //zenoline.co.kr

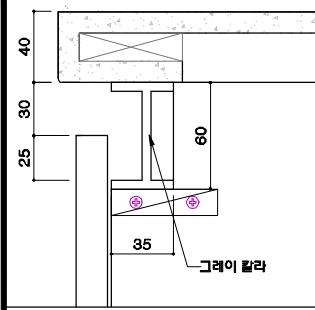

하부장 손잡이 DETAIL

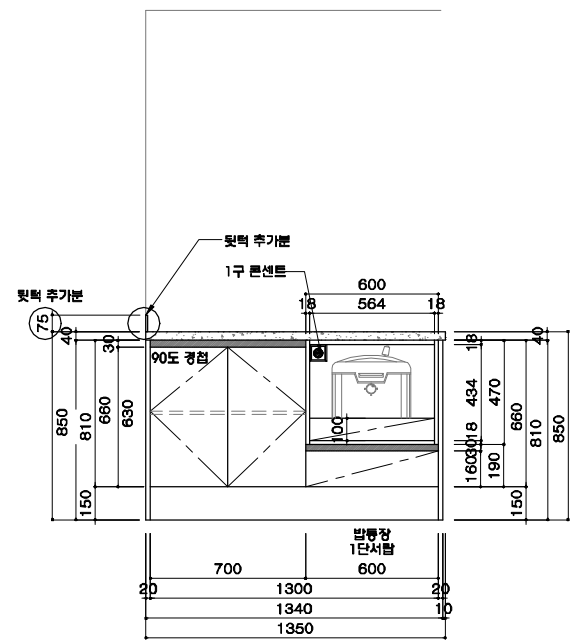

ELEVATION

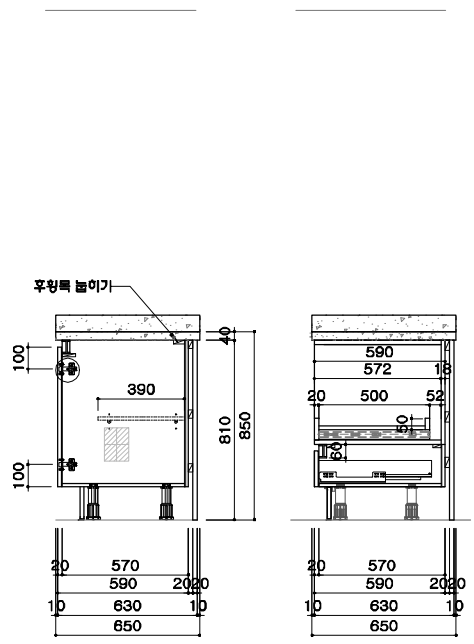

SIDE VIEW

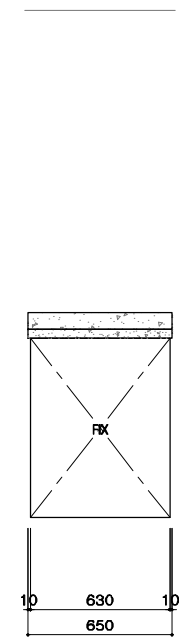

ELEVATION

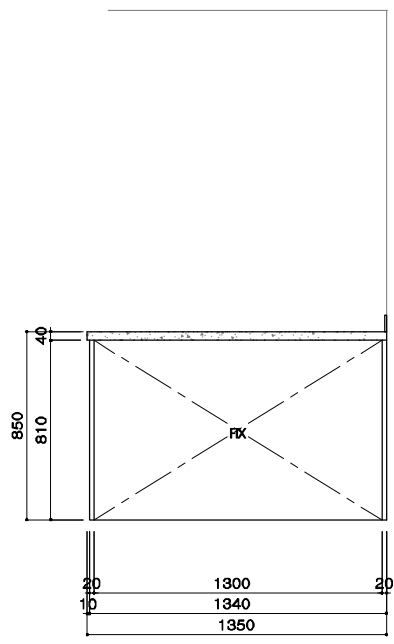

ELEVATION

승인
2020. 07. 14.
ZENOLINE

2		
1		
NO.	수정일	도면수정내용
SCALE NON SCALE		
DATE 2020. 07. 14.		
DRAWN BY		김민정

ZENOLINE
(주) 제노라인

경남 김해시 상림면 나전로 238-25
TEL. 056) 323 - 8866 FAX. 056) 323 - 8835
Homepage : http : //zenoline.co.kr

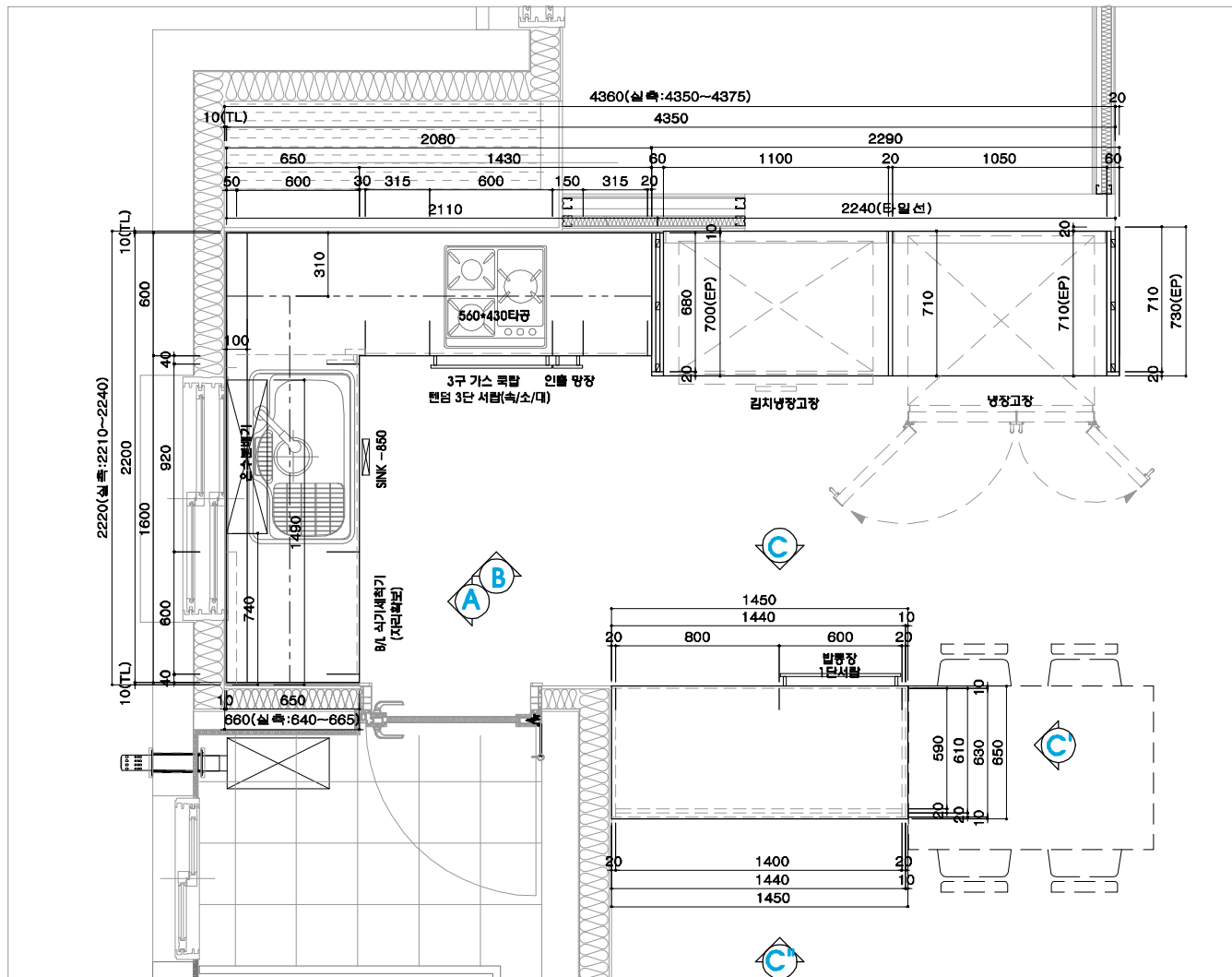

PLAN OF KITCHEN

승인
 2020. 07. 14.
 ZENOLINE

2		
1		
NO.	수정일	도면수정내용
SCALE NON SCALE		
DATE 2020. 07. 14.		
DRAWN BY 김민정		

ZENOLINE
 (주) 제노라인
 경남 김해시 상림면 나전로 238-25
 TEL. 056) 323 - 8866 FAX. 056) 323 - 8835
 Homepage : http : //zenonline.co.kr

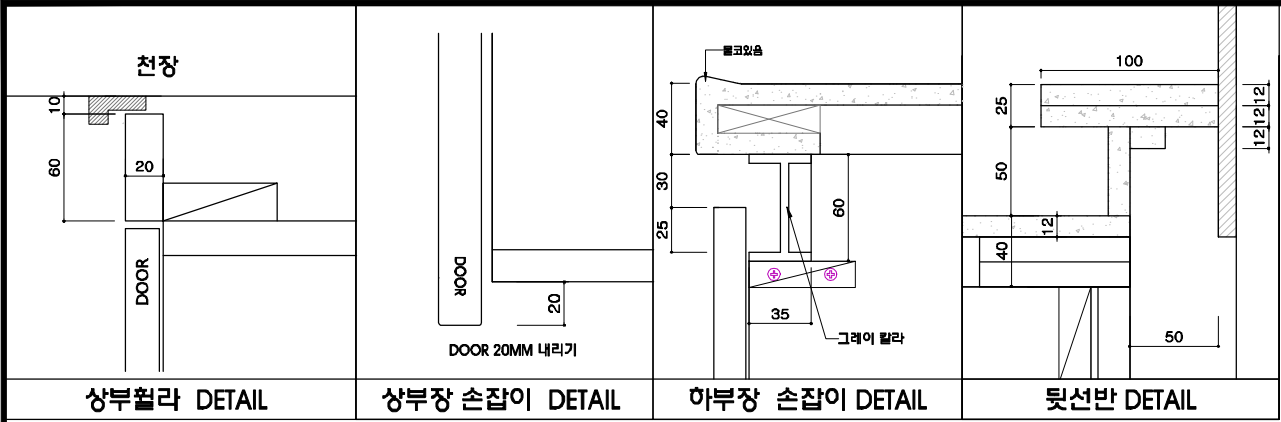

상부철라 DETAIL

상부장 손잡이 DETAIL

하부장 손잡이 DETAIL

뒷선반 DETAIL

현장명 **LH 현대건설**
충주호암지구 A-1BL

TYPE	59㎡C type
ITEM	KITCHEN
도면방향	25 - SET
도면반대	24 - SET
총수량	49 - SET

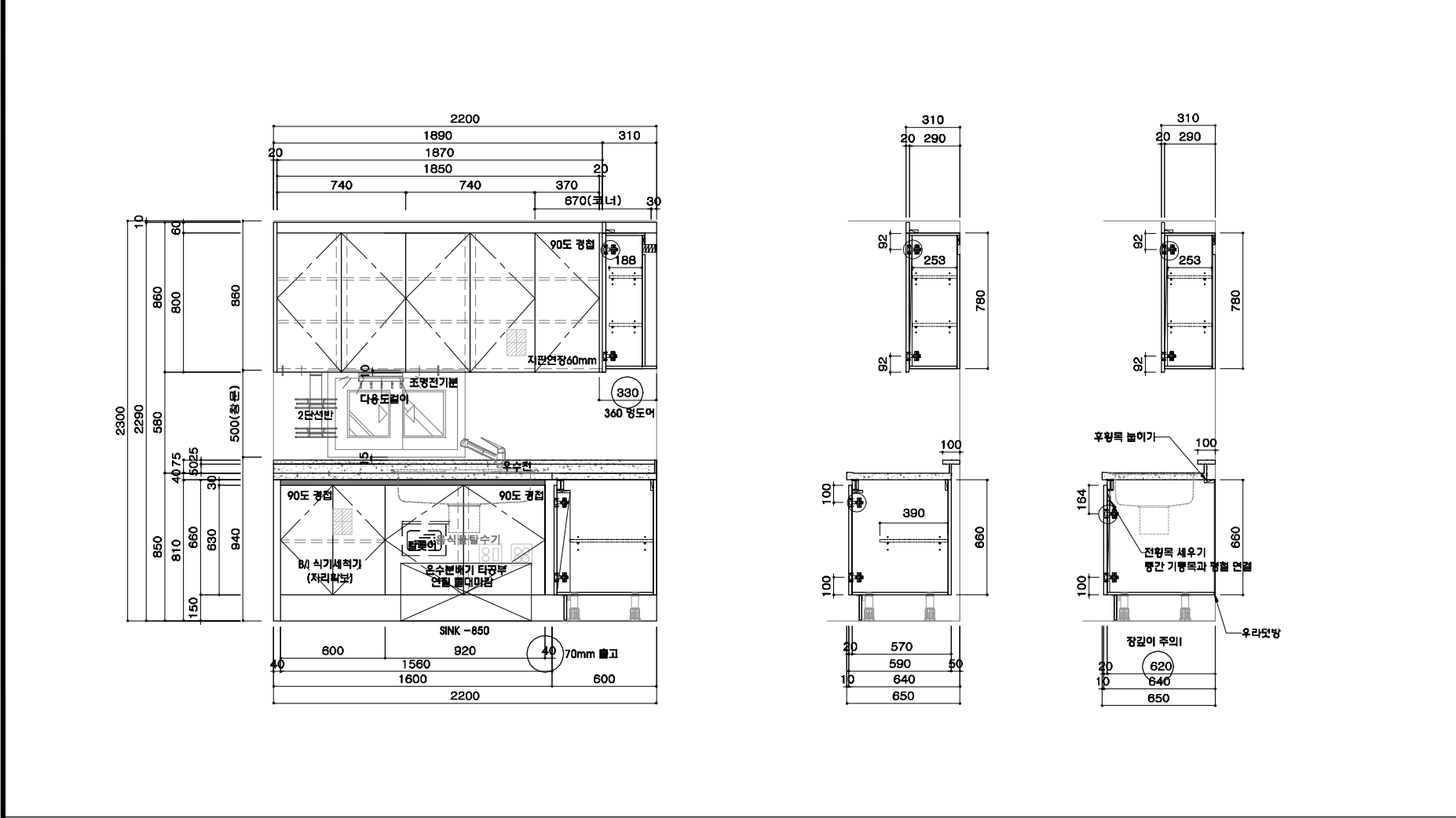

2		
1		
NO.	수정일	도면수정내용
SCALE NON SCALE		
DATE 2020. 07. 14.		
DRAWN BY		김민정

ZENOLINE
 (주) 제노라인

경남 김해시 상림면 나전로 238-25
 TEL. 056) 323 - 8866 FAX. 056) 323 - 8835
 Homepage : http://zenoline.co.kr

DOOR

DOOR 20MM 내리기

상부장 손잡이 DETAIL

상부 점검구 DETAIL

후드장 상세도

후드장 천판 타공도

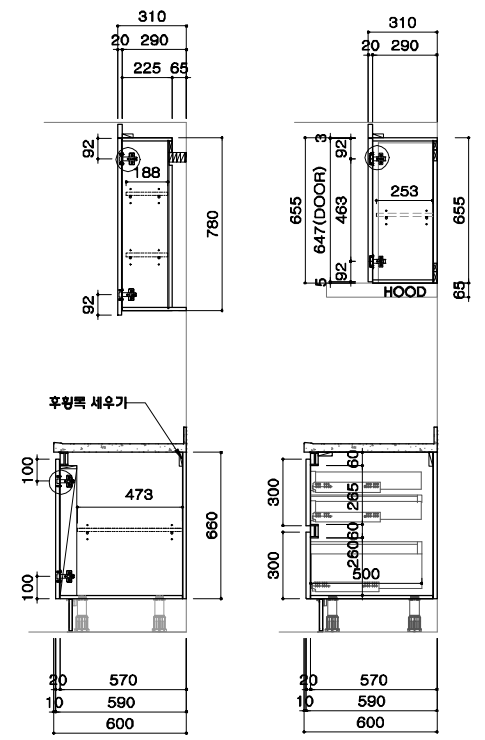
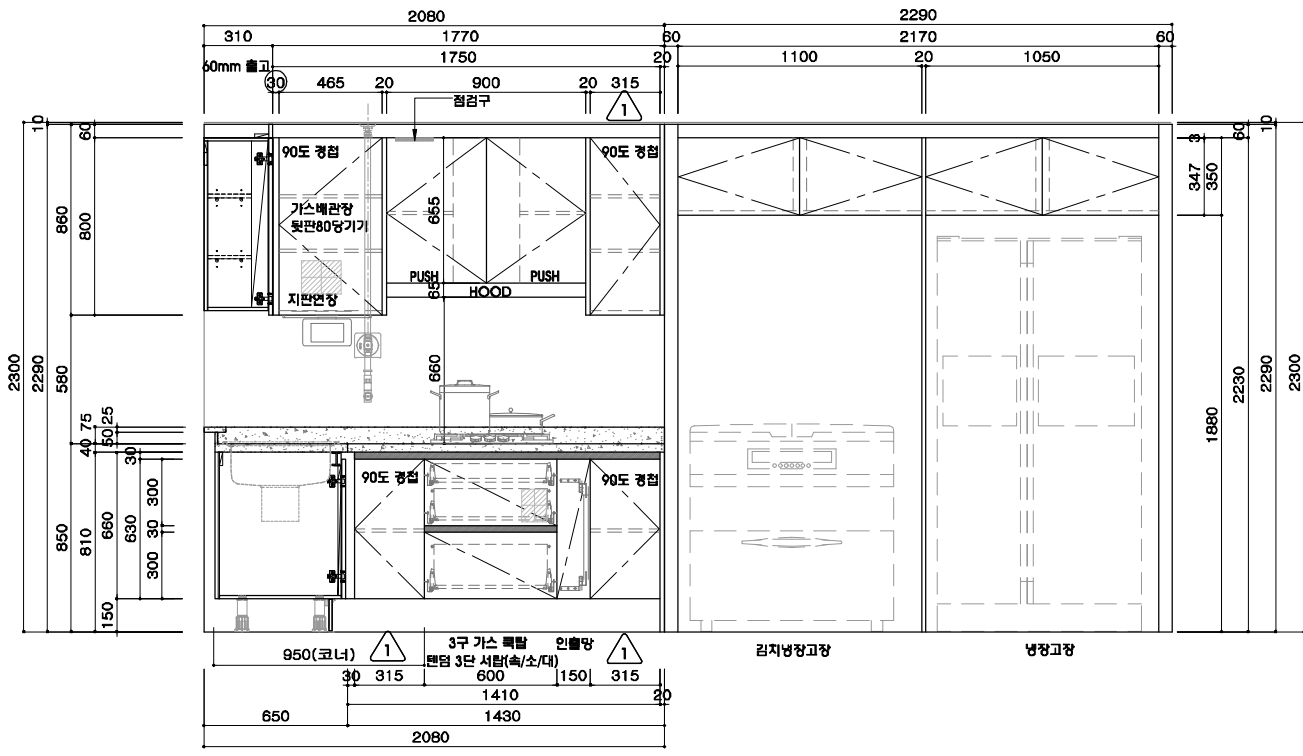

현장명 **LH 현대건설**
충주호암지구 A-1BL

TYPE **59㎡C type**

ITEM **KITCHEN**

도면방향	25 - SET
도면반대	24 - SET
총수량	49 - SET



2		
1	7.14	일면사이즈수정
NO.	수정일	도면수정내용
SCALE NON SCALE		
DATE 2020. 07. 14.		
DRAWN BY		김민정

ZENOLINE
 (주) 제노라인

경남 김해시 상림면 나전로 238-26
 TEL. 056) 323 - 8866 FAX. 056) 323 - 8835
 Homepage : http : //zenoline.co.kr

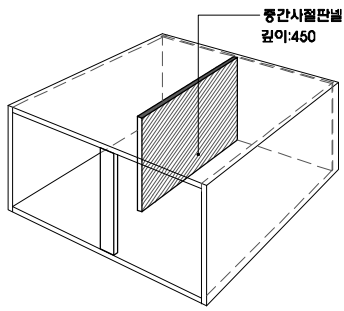

냉장고장 상부장 DETAIL

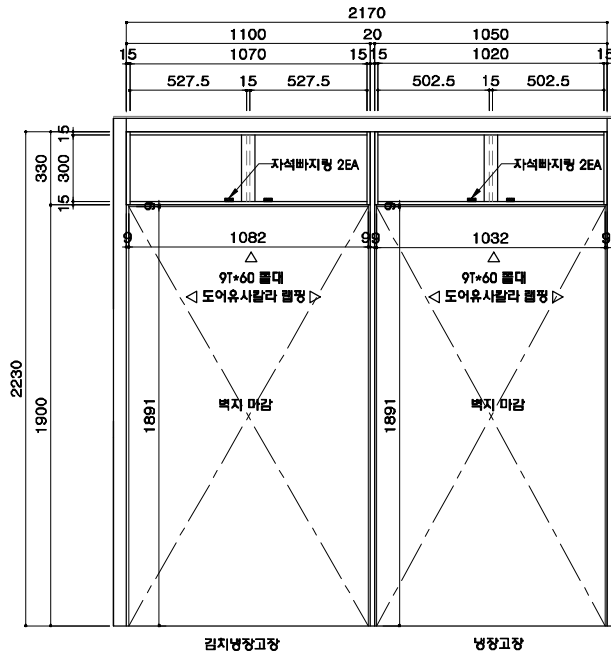

INNER VIEW

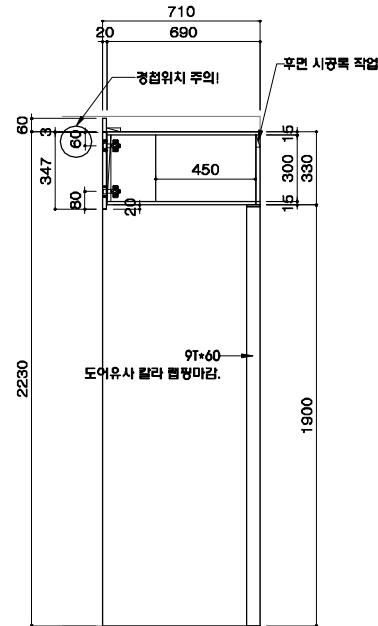

SIDE VIEW

현장명 LH 현대건설
충주호암지구 A-1BL

TYPE	59㎡C type
ITEM	KITCHEN
도면방향	25 - SET
도면반대	24 - SET
총수량	49 - SET



2		
1		
NO.	수정일	도면수정내용
SCALE NON SCALE		
DATE 2020. 07. 14.		
DRAWN BY 김민정		

ZENOLINE
(주) 제노라인

경남 김해시 상림면 나전로 238-25
TEL. 056) 323 - 8866 FAX. 056) 323 - 8835
Homepage : http : //zenoline.co.kr

SHEET NO.

16

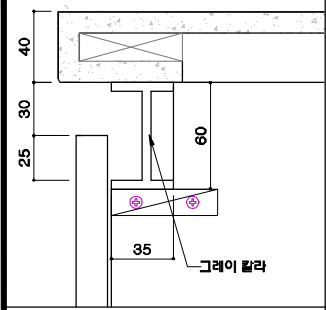

하부장 손잡이 DETAIL

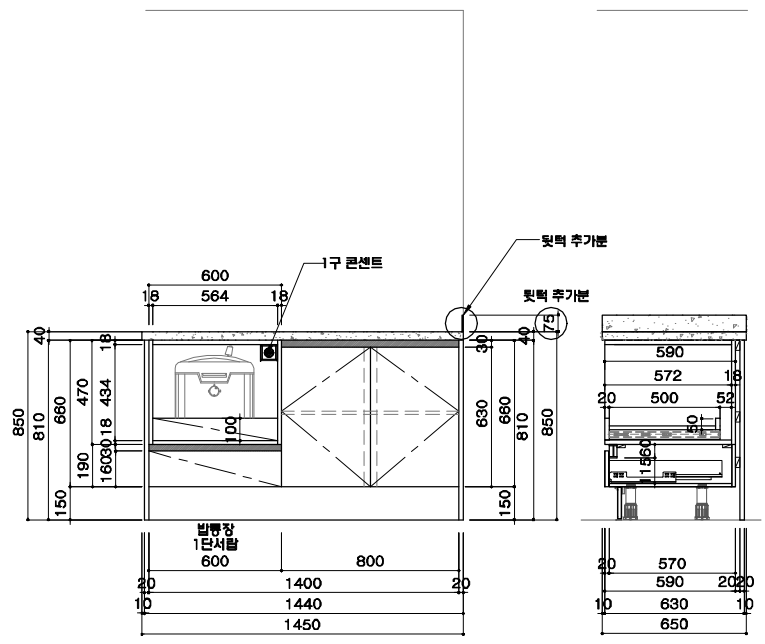

30	1400	20
10	1440	
	1450	

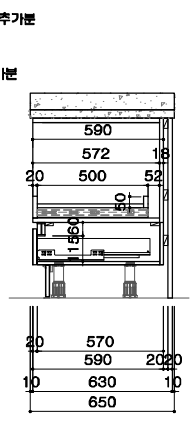

20	570	
	590	20
10	630	10
	650	

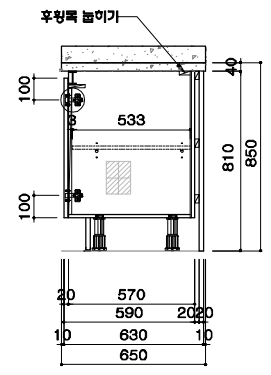

20	570	
	590	20
10	630	10
	650	

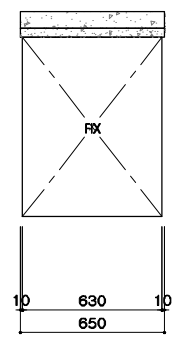

10	630	10
	650	

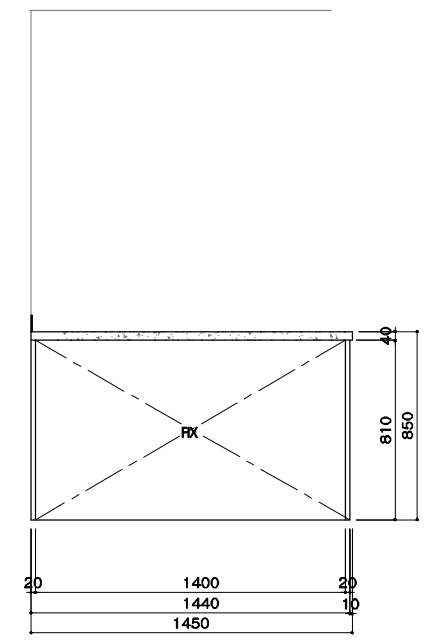

20	1400	20
	1440	
	1450	



2		
1		

NO. 수정일 도면수정내용

SCALE **NON SCALE**

DATE **2020. 07. 14.**

DRAWN BY **김민정**

ZENOLINE
(주) 제노라인

경남 김해시 상림면 나전로 238-25
TEL. 055) 323 - 8866 FAX. 055) 323 - 8835
Homepage : http://zenoline.co.kr

SHEET NO. **17**

SPECIFICATION			ITEM	
상부장	DOOR	THK18 MDF	BODY	THK15 PB
	전면	지정PET (DAPET 037M 기준)	전면	지정 LPM (PTA-423)
	후면	지정 PP(DC100)	엣지	0.6T 지정 P.P (TLG0129MU)
	엣지	1.0T 지정 PET엣지 (도어전면 유사)	뒷판	3T HDF 피니싱호일마감
	손잡이	자체손잡이		
하부장	DOOR	THK18 MDF	HARDWARE & ACCESSORY	
	전면	지정PET (DAPET 037M 기준)	상 판	MMA 상판 (기준: LG 하우스 G135)
	후면	지정 PP(DC100)	싱크볼	850 언더싱크용 (물걸음바구니 / 수세미망 포함)
	엣지	1.0T 지정 PET엣지 (도어전면 유사)	힌 지	Dowel은 Anochor 타입 적용(탈착식 구조 / 뎀핑기능)
	손잡이	A/L 손잡이 (진그레이)	인출망	인출망 고급형 (DA-91-133)
키친장	DOOR	THK18 MDF	조리기구걸이 세트	2단 선반형 (DA-91-123)
	전면	지정PET (DAPET 037M 기준)	칼꽂이	보류
	후면	지정 PP(DC100)	시스템서랍장	뎀핑, 자동닫힘
	엣지	1.0T 지정 PET엣지 (도어전면 유사)	슬라이딩레일	PVC 레일
컬래반이	도어동일마감		1구콘센트	보류
			기계공사	
			후 드	DAC-90S (하츠)
			3구 가스쿡탑	RBR-S341OBSJ
			음식물탈수기	
			전기공사	
			조명	



2		
1		
NO.	수정일	도면수정내용
SCALE NON SCALE		
DATE 2020. 07. 14.		
DRAWN BY 김민정		

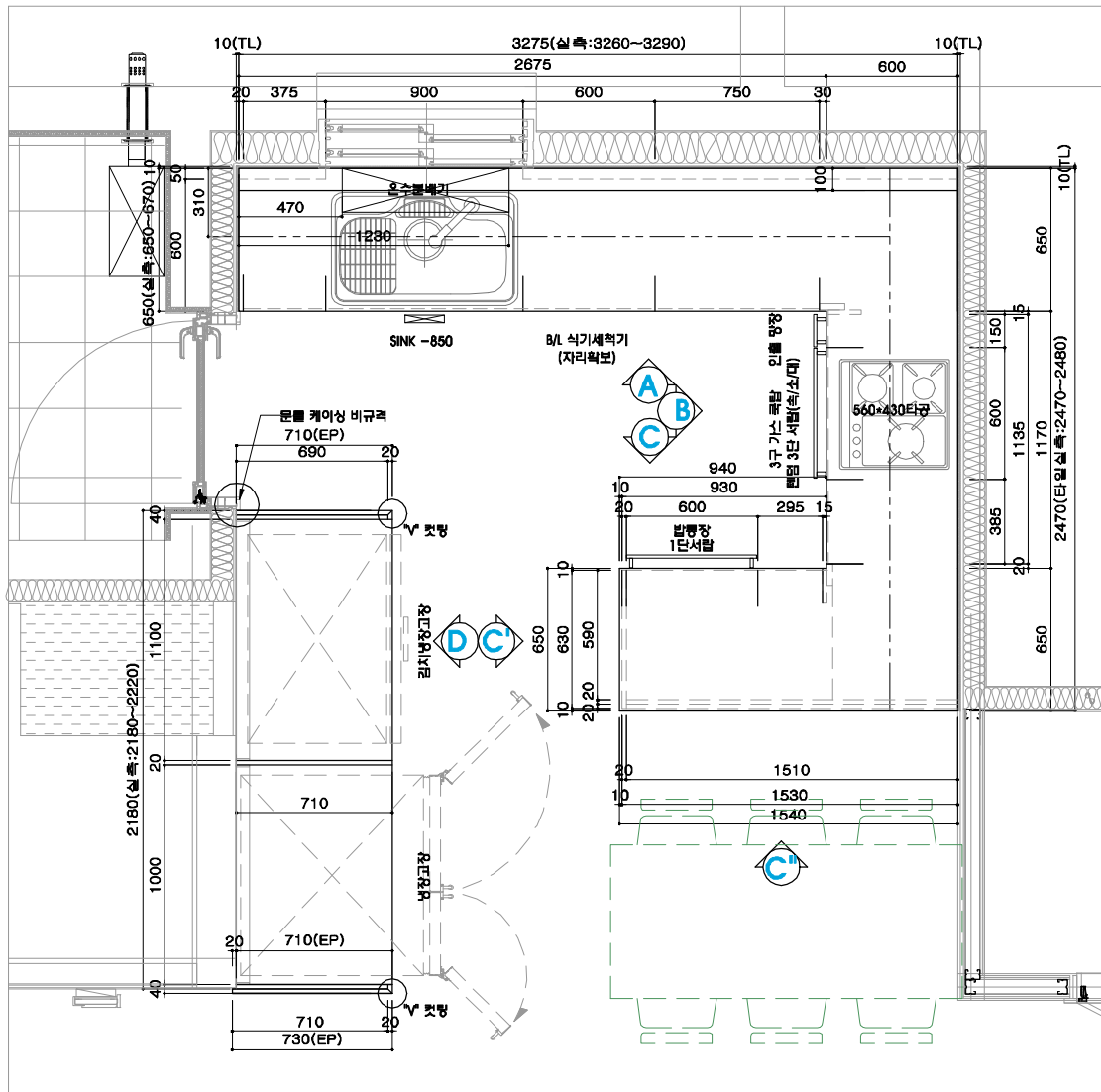

PLAN OF KITCHEN

승인
 2020. 07. 14.
 ZENOLINE

2		
1		
NO.	수정일	도면수정내용
SCALE NON SCALE		
DATE 2020. 07. 14.		
DRAWN BY 김민정		

ZENOLINE
 (주) 제노라인
 경남 김해시 상림면 나전로 238-26
 TEL. 056) 323 - 8866 FAX. 056) 323 - 8835
 Homepage : http : //zenoline.co.kr

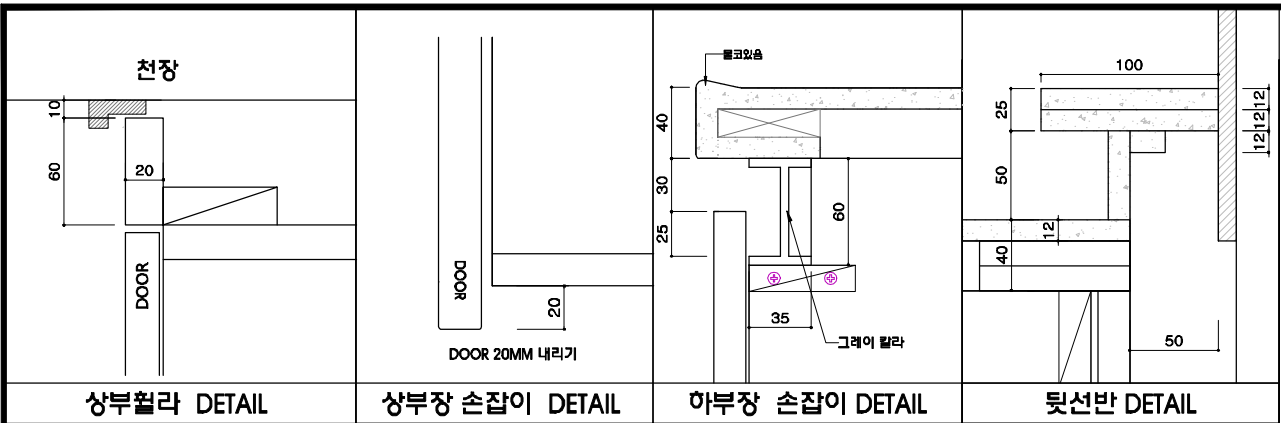

상부철라 DETAIL

상부장 손잡이 DETAIL

하부장 손잡이 DETAIL

뒷선반 DETAIL

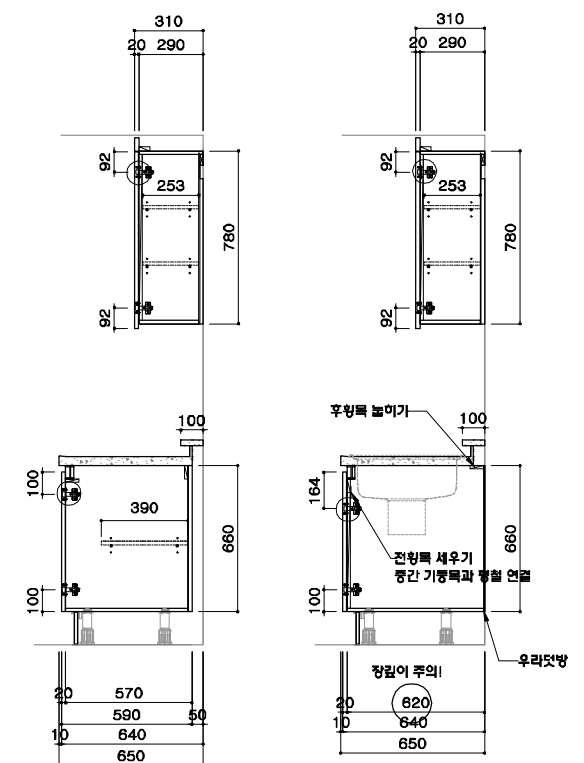
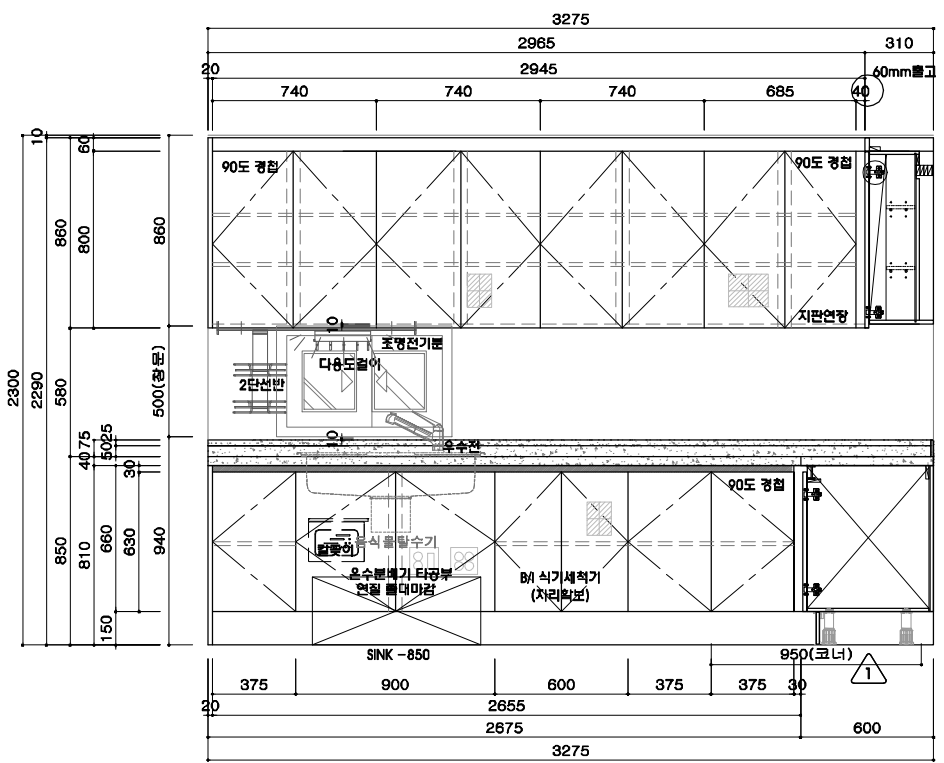

SIDE VIEW

현장명 **LH 현대건설**
충주호암지구 A-1BL

TYPE	59㎡D type
ITEM	KITCHEN
도면방향	138 - SET
도면반대	24 - SET
총수량	162 - SET



2		
1	7.15	하부코너장 사이즈
NO.	수정일	도면수정내용
SCALE NON SCALE		
DATE 2020. 07. 14.		
DRAWN BY 김민정		

ZENOLINE
 (주) 제노라인

경남 김해시 상림면 나전로 238-25
 TEL. 055) 323 - 8866 FAX. 055) 323 - 8835
 Homepage : http : //zenoline.co.kr

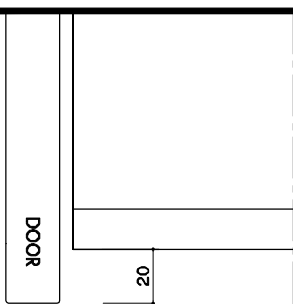

DOOR 20MM 내리기

상부장 손잡이 DETAIL

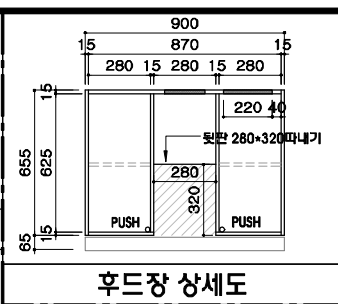

후드장 상세도

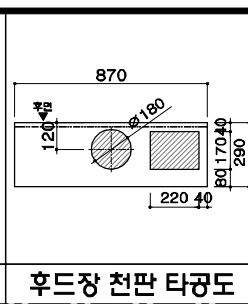

후드장 천판 타공도

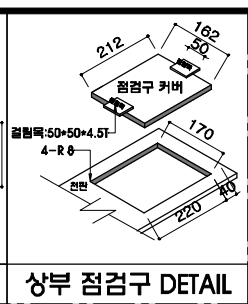

상부 점검구 DETAIL

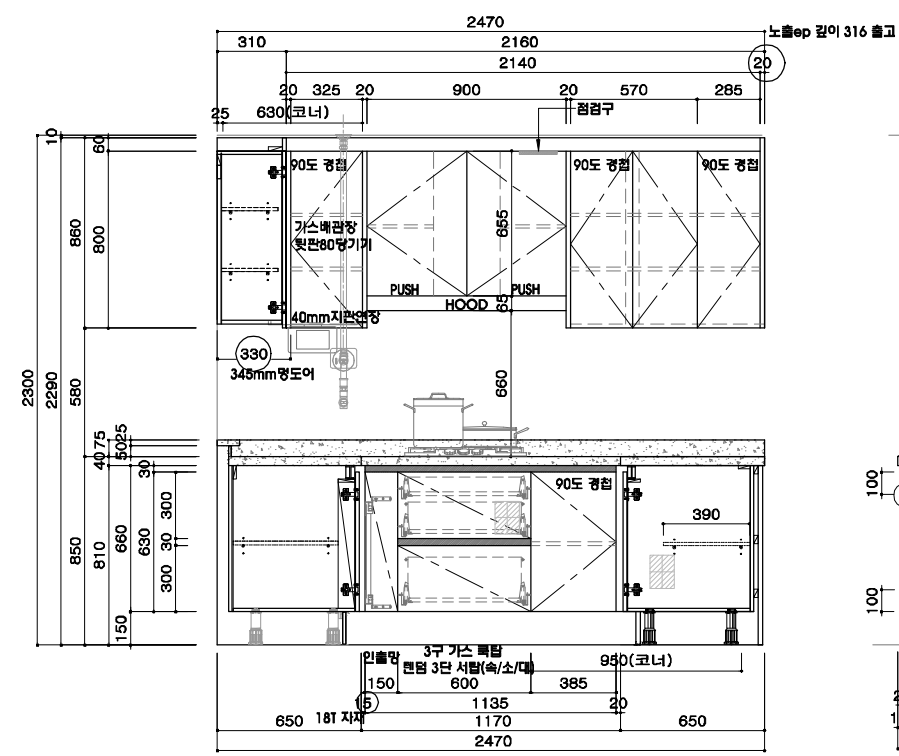

FRONT ELEVATION

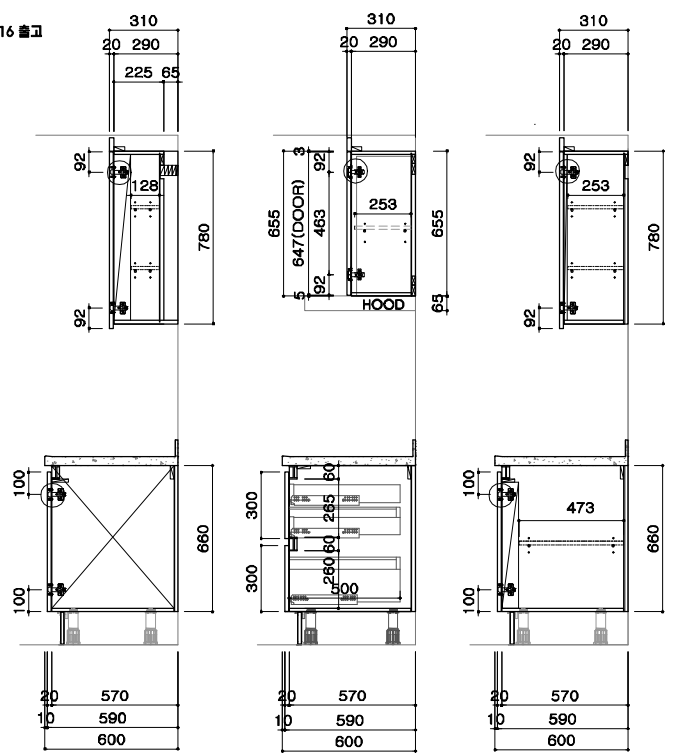

SIDE VIEW

현장명 LH 현대건설
 층주호암지구 A-1BL

TYPE	59㎡D type
ITEM	KITCHEN
도면방향	138 - SET
도면반대	24 - SET
총수량	162 - SET



2		
1		
NO.	수정일	도면수정내용
SCALE NON SCALE		
DATE 2020. 07. 14.		
DRAWN BY		김민정

ZENOLINE
 (주) 제노라인
 경남 김해시 상림면 나전로 238-26
 TEL. 056) 323 - 8866 FAX. 056) 323 - 8835
 Homepage : http : //zenoline.co.kr

TYPE	59m ² D type
ITEM	KITCHEN
도면방향	138 - SET
도면반대	24 - SET
총수량	162 - SET

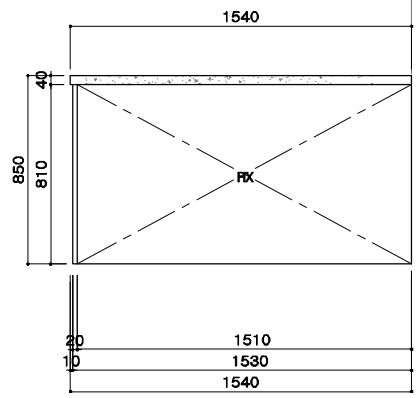
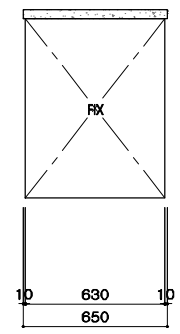
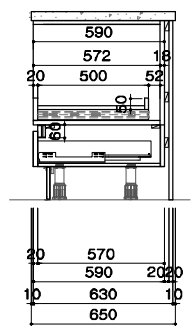
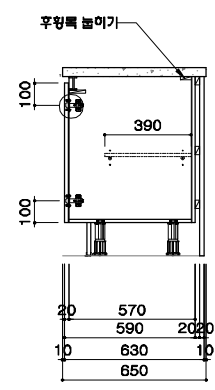
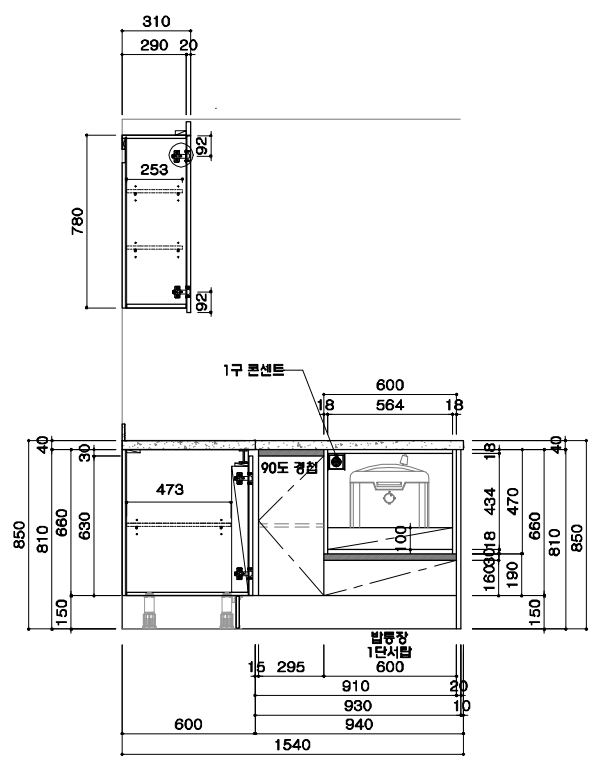

승인
2020. 07. 14.
ZENOLINE

2		
1		
NO.	수정일	도면수정내용
SCALE NON SCALE		
DATE 2020. 07. 14.		
DRAWN BY 김민정		

ZENOLINE
(주) 제노라인

경남 김해시 상림면 나전로 238-26
TEL. 056) 323 - 8866 FAX. 056) 323 - 8835
Homepage : <http://zenoline.co.kr>

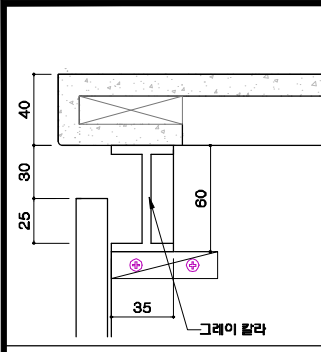

하부장 손잡이 DETAIL

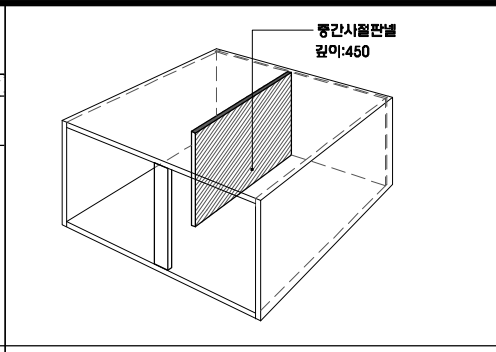

냉장고장 상부장 DETAIL

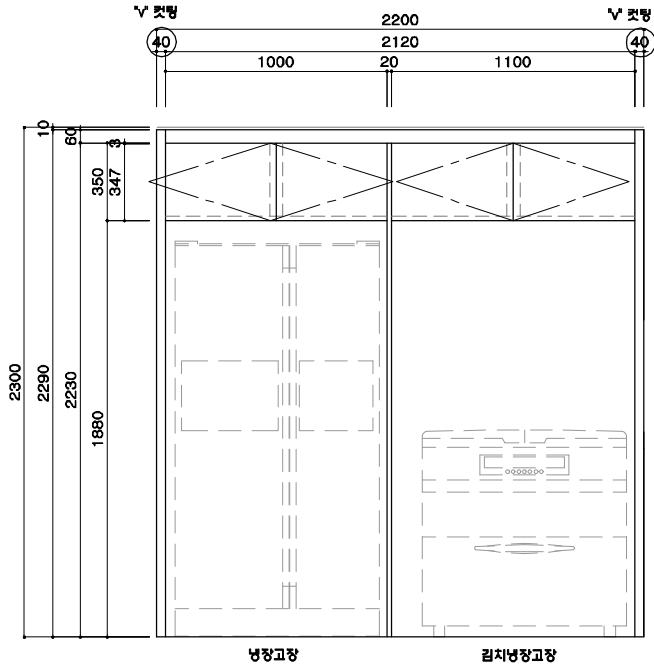

냉장고장

김치냉장고장

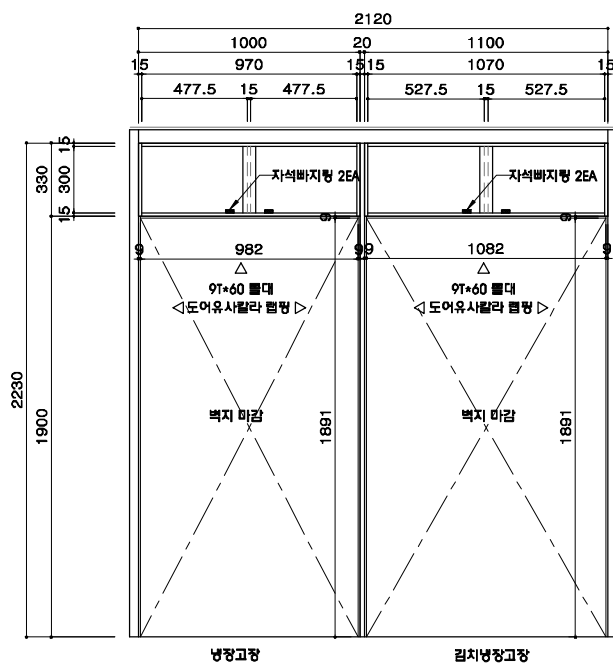

냉장고장

김치냉장고장

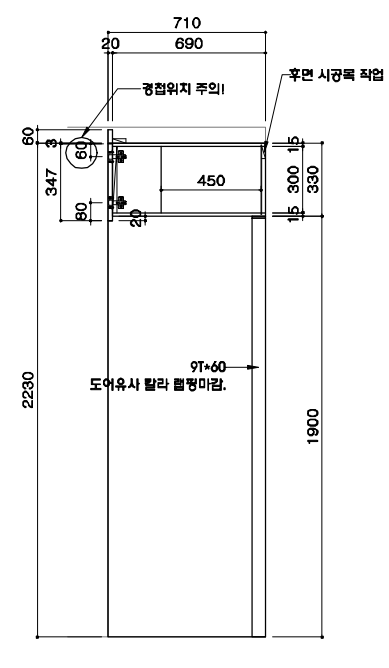

SIDE VIEW

현장명 **LH 현대건설**
충주호암지구 A-1BL

TYPE	59m ² D type
ITEM	KITCHEN
도면방향	138 - SET
도면반대	24 - SET
총수량	162 - SET



2		
1		
NO.	수정일	도면수정내용
SCALE NON SCALE		
DATE 2020. 07. 14.		
DRAWN BY 김민정		

ZENOLINE
 (주) 제노라인

경남 김해시 상림면 나전로 238-25
 TEL. 055) 323 - 8866 FAX. 055) 323 - 8835
 Homepage : http : //zenoline.co.kr

SHEET NO. **23**